

**OLYMPUS®**

DIGITAL CAMERA

**E-3**

# INSTRUCTION MANUAL

**Basic guide** P. 2

Review the camera part names and the basic steps for shooting and playback.

**Table of Contents** P. 20



- Before you start to use your new camera, please read the “Safety Precautions” section in this manual.
- We recommend that you take test shots to get accustomed to your camera before taking important photographs.
- The screen and camera illustrations shown in this manual were produced during the development stages and may differ from the actual product.
- The contents in this manual are based on firmware version 1.0 for this camera. If there are addition and/or modification of functions due to firmware update for the camera, the contents will differ. For the latest information, please visit the Olympus website.

# Camera

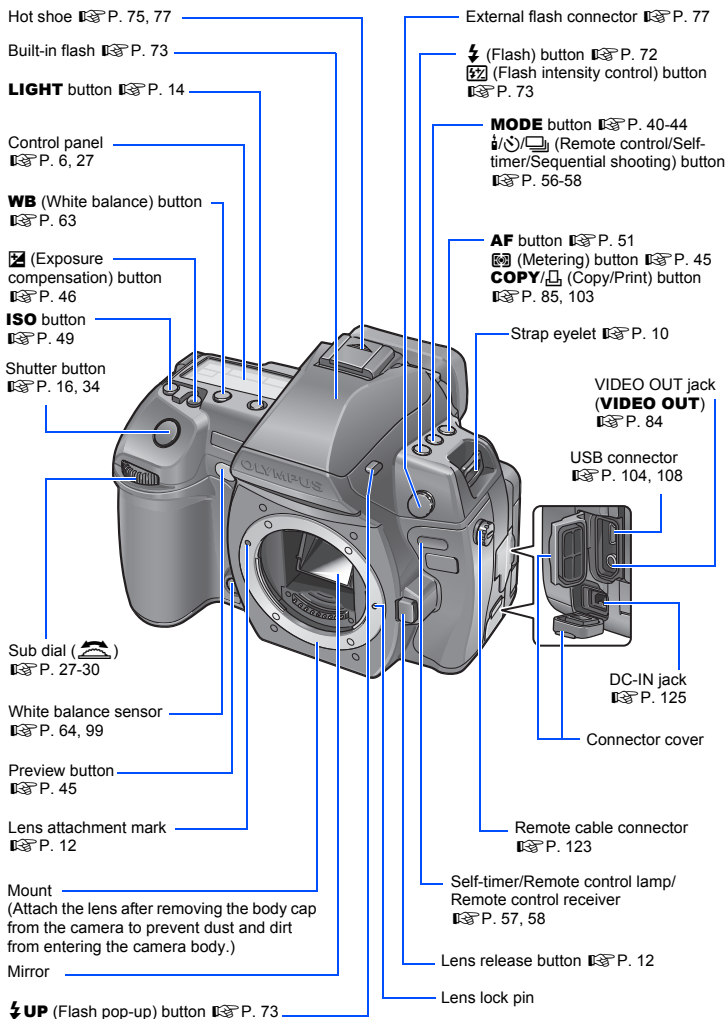

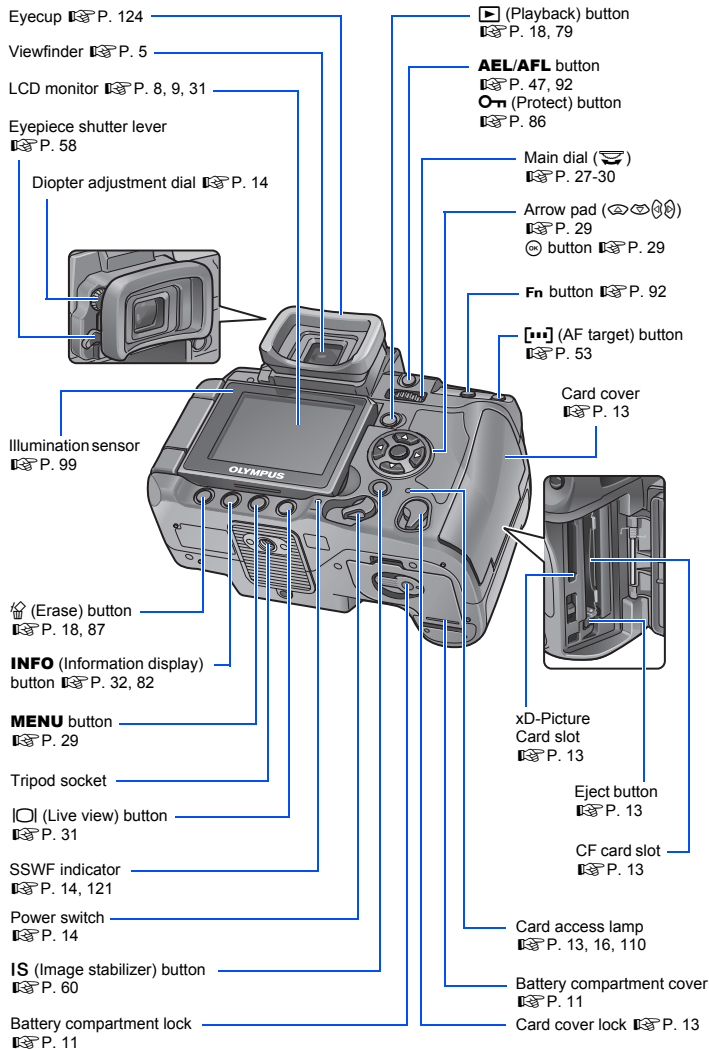

# Direct buttons

You can set the following functions. Turn the dials while pressing the direct buttons.  
☞ "Using the direct buttons" (P. 27)

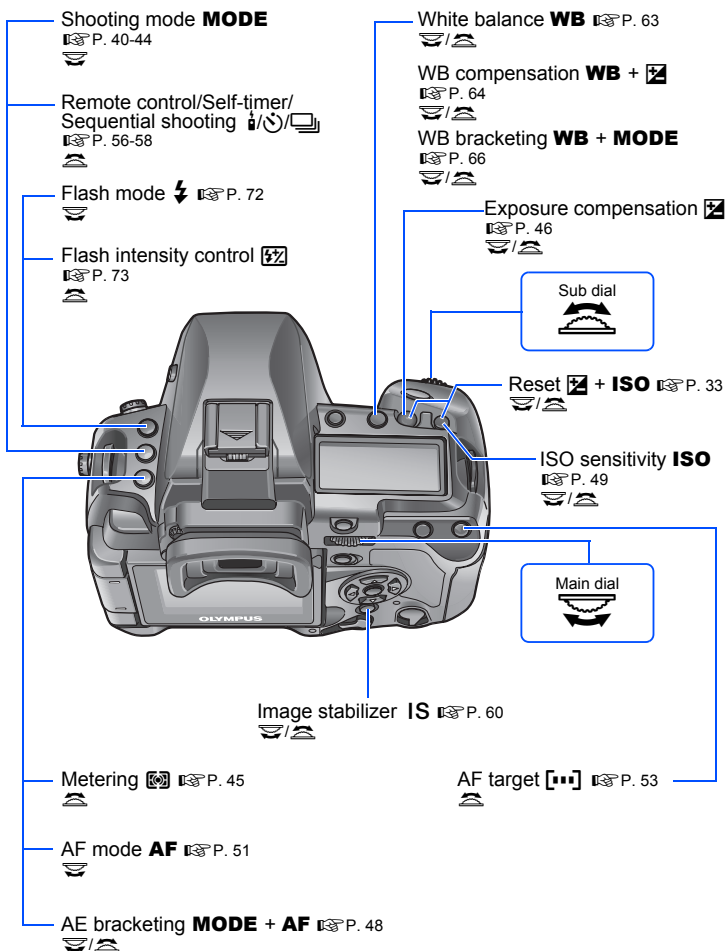

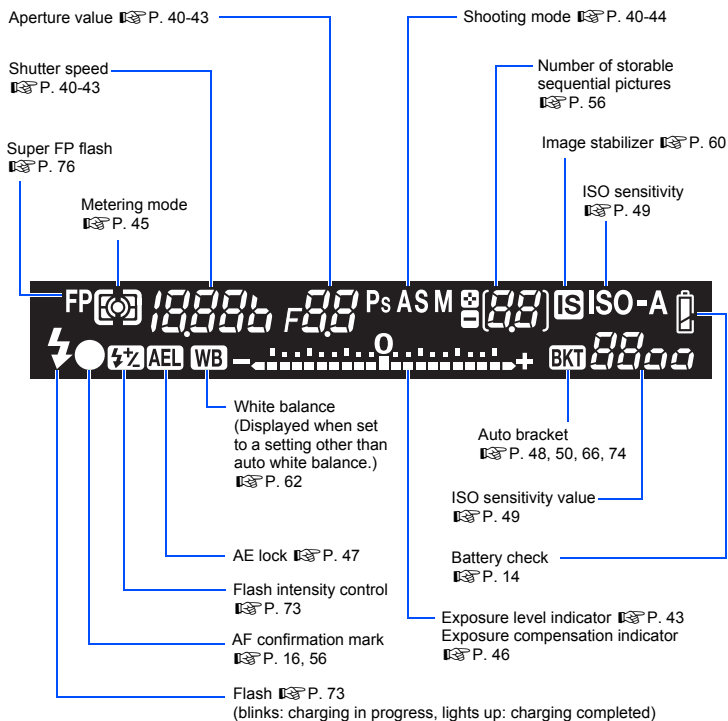
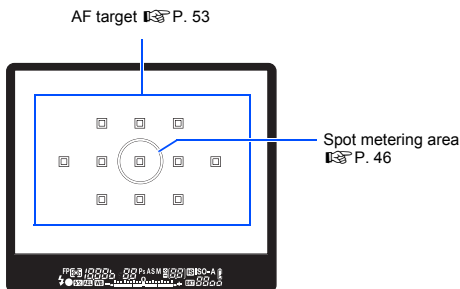

# Control panel

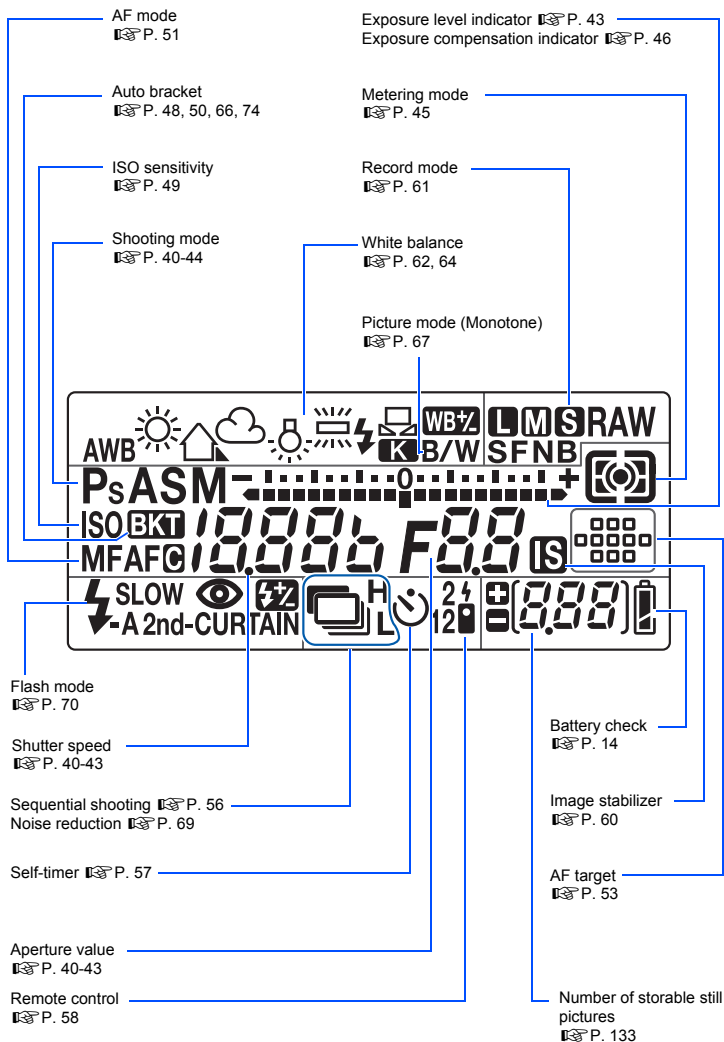

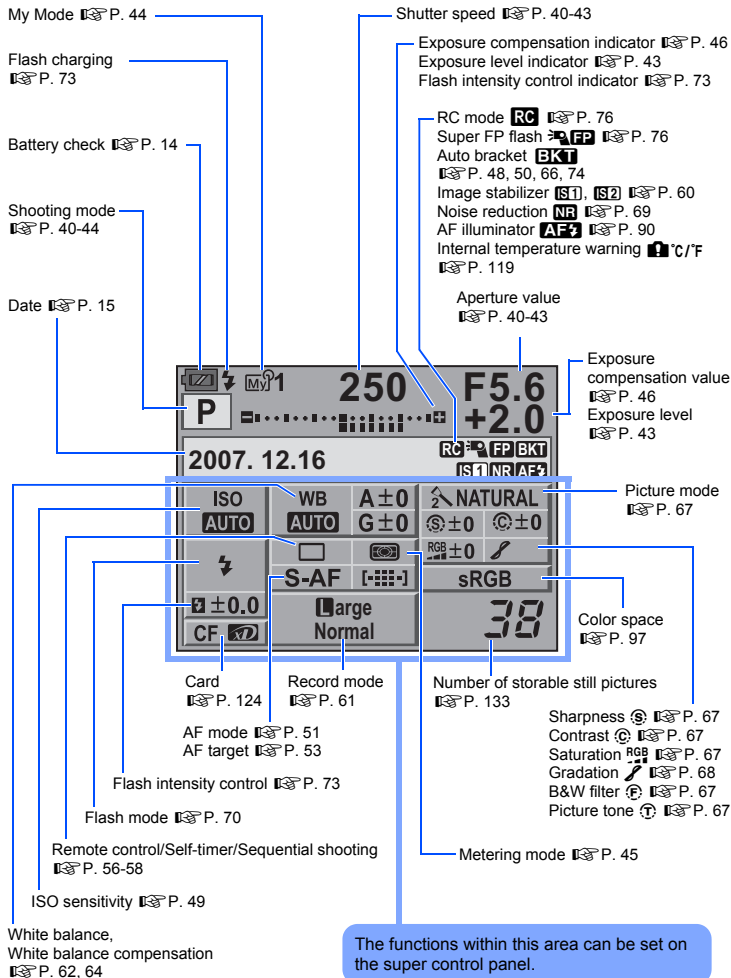

# Super control panel

The following screen allows the display and setting of shooting settings at the same time and is called the super control panel. Press the **INFO** button to display the super control panel on the LCD monitor. "Using the super control panel" (P. 28)



# LCD monitor (Live view)

You can use the LCD monitor to view the subject while shooting. Press the  button to use live view.  "Using live view" (P. 31)

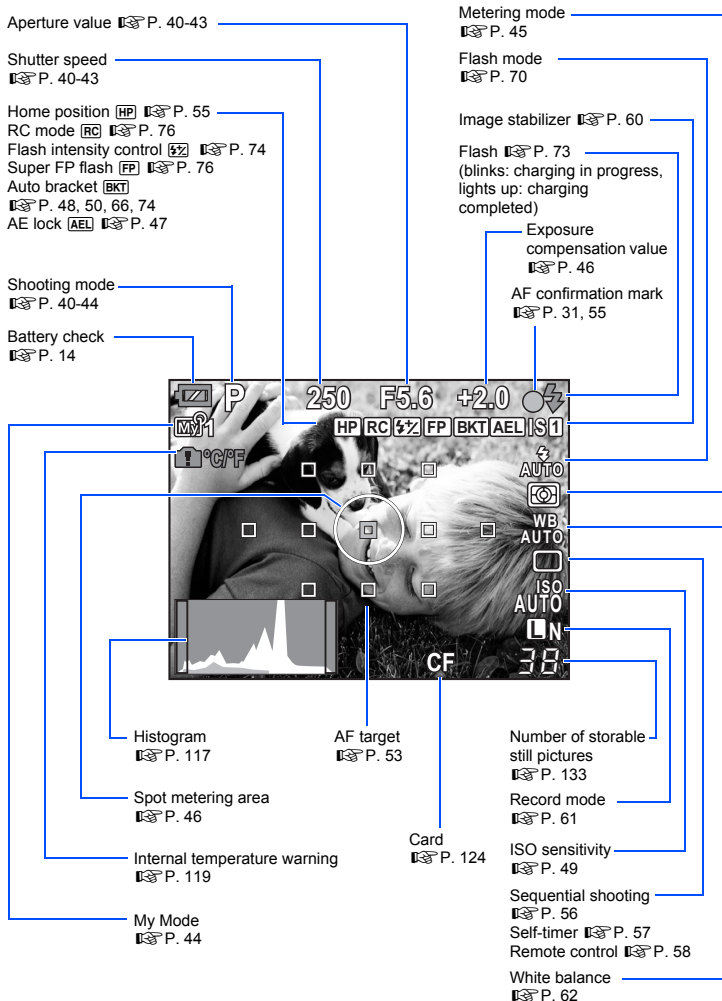



# LCD monitor (Playback)

You can switch the monitor display using the **INFO** button.

☰ "Information display" (P. 82)

Record mode ☰ P. 61

Battery check ☰ P. 14

Card ☰ P. 124

Print reservation  
Number of prints  
☰ P. 101

Protect  
☰ P. 86



File number  
☰ P. 82

Frame number  
☰ P. 82

Date and time  
☰ P. 15

AF target ☰ P. 53

Histogram ☰ P. 82

Metering mode ☰ P. 45

White balance ☰ P. 62

Focal distance ☰ P. 126  
(The focal distance is displayed in 1 mm units.)

Shooting mode ☰ P. 40-44

Aperture value ☰ P. 40-43

Shutter speed  
☰ P. 40-43

Exposure compensation  
☰ P. 46

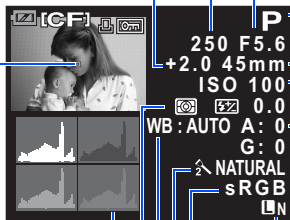

Record mode  
☰ P. 61

Color space  
☰ P. 97

Picture mode  
☰ P. 67

White balance compensation  
☰ P. 64

Flash intensity control ☰ P. 73

ISO sensitivity ☰ P. 49

# Unpack the box contents

The following items are included with the camera.

If anything is missing or damaged, contact the dealer from whom you purchased the camera.



Camera



Body cap



Strap

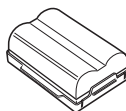

BLM-1 Lithium ion battery



BCM-2 Lithium ion charger

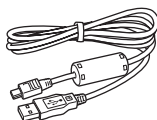

USB cable

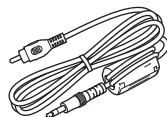

Video cable



OLYMPUS Master 2 CD-ROM



Instruction manual



Warranty card

## Attaching the strap

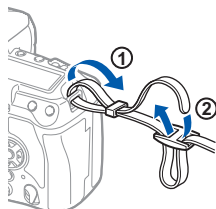

Thread the strap as indicated by the arrows (①, ②).

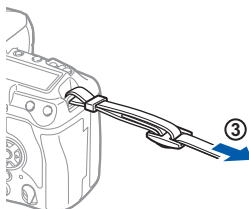

Lastly, pull the strap tight making sure that it is fastened securely (③).

Attach the other end of the strap to the other eyelet in the same way.

# Preparing the battery

## 1 Charging the battery

Charging indicator  
Red light: Charging in progress  
Green light: Charging completed  
(Charging time: Approx. 5 hours)

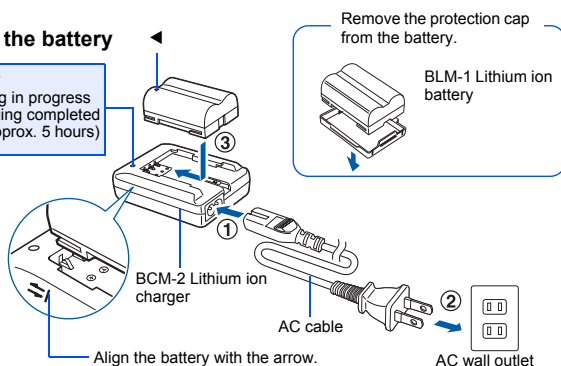

## 2 Loading the battery

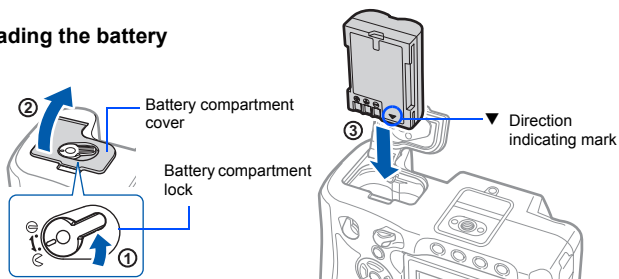

## 3 Close the battery compartment cover and slide the battery compartment lock in the direction of ⊖

### Unloading the battery

Press the battery lock to unlock the battery. Turn the camera upside-down to remove the battery.

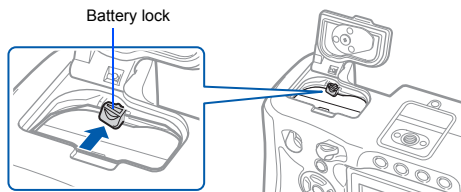

It is recommended to set aside a backup battery for prolonged shooting in case the battery in use drains.

# Attaching a lens to the camera

- 1 Remove the body cap from the camera and the rear cap from the lens

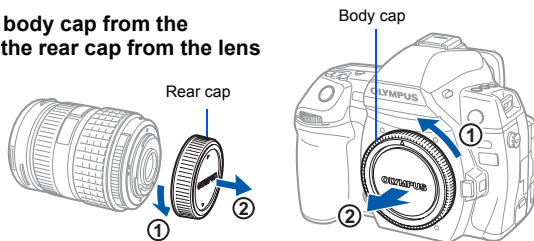

- 2 Attach a lens to the camera

- Align the lens attachment mark (red) on the camera with the alignment mark (red) on the lens, then insert the lens into the camera's body (1).
- Rotate the lens in the direction indicated by the arrow until you hear it click (2).

Do not press the lens release button.

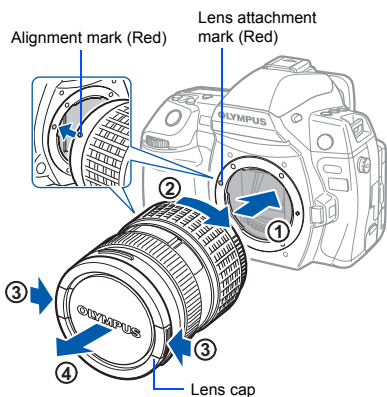

- 3 Remove the lens cap (3, 4)

## Removing the lens from the camera

While pressing the lens release button (1), rotate the lens in the direction of the arrow (2).

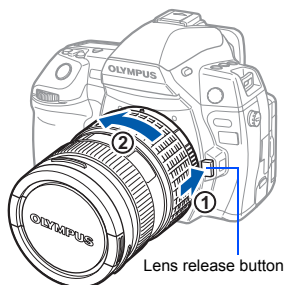

# Loading the card

## CompactFlash/Microdrive

Slide the card cover lock (①) and open the card cover.  
Insert the card's contact area into the slot as far as it can go (②).

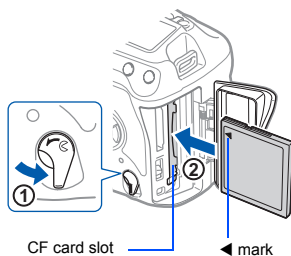

## xD-Picture Card

Slide the card cover lock (①) and open the card cover.  
Insert the card until it is locked into place (②).

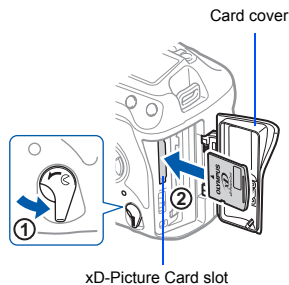

## Removing the card

Never open the card cover while the card access lamp is blinking.

## CompactFlash/Microdrive

- Press the eject button all the way in to eject the card.
- Pull out the card.

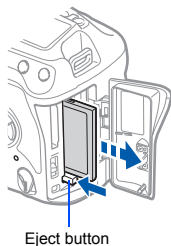

## xD-Picture Card

- Press the inserted card lightly and it will be ejected.
- Pull out the card.

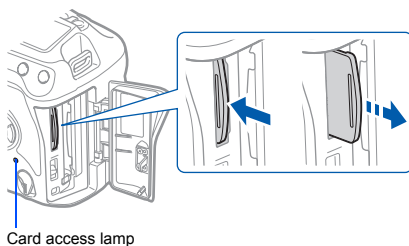

# Power on

## 1 Set the camera's power switch to ON

- To turn off the power, set the power switch to OFF.

### LIGHT button

Turns the control panel light on and off.

### Control panel

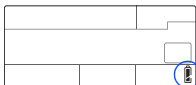

When the camera is turned on, the battery check is displayed on the control panel.

- Lit up (ready for use)
- Blinks (charging required)

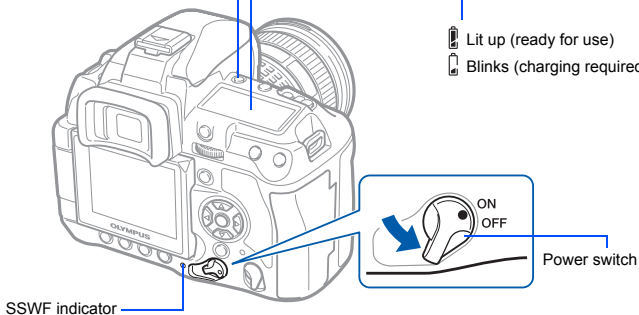

### Dust reduction function operation

The dust reduction function is automatically activated when the camera is turned on. Ultrasonic vibrations are used to remove dust and dirt from the image pickup device's filter surface. The SSWF (Super Sonic Wave Filter) indicator blinks while dust reduction is working.

### Adjusting the viewfinder's diopter

Adjust the viewfinder's diopter in accordance with your vision.

While looking through the viewfinder, rotate the diopter adjustment dial little by little.

When you can see the AF target clearly, adjustment is complete.

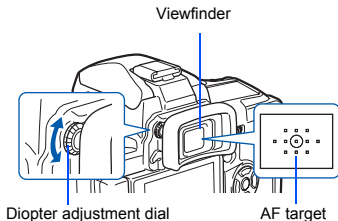

# Setting the date/time

Date and time information is recorded on the card together with the images. The file name is also included with the date and time information. Be sure to set the correct date and time before using the camera.

## 1 Press the **MENU** button

- The menu screen is displayed on the LCD monitor.

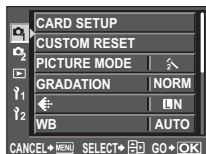

## 2 Use to select [1/2], then press

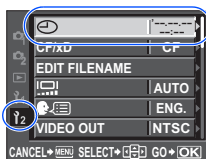

## 3 Use to select [Y], then press

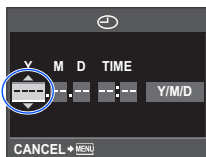

## 4 Use to select [Y], then press

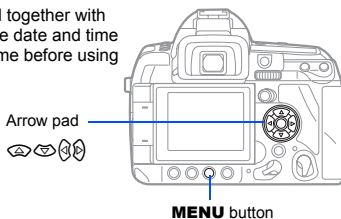
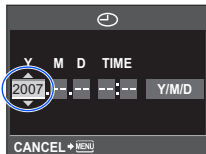

## 5 Repeat this procedure until the date and time are completely set

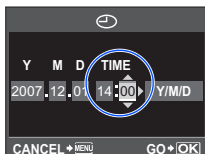

- The time is displayed in the 24-hour format.

## 6 Use to select the date format



## 7 Press the button



## 8 Press the **MENU** button to exit

# Shooting

- 1 Place the AF target on the subject while viewing through the viewfinder

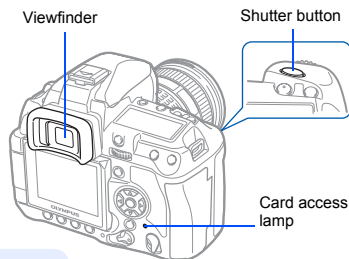

- 2 Adjust the focus

Press the shutter button halfway.

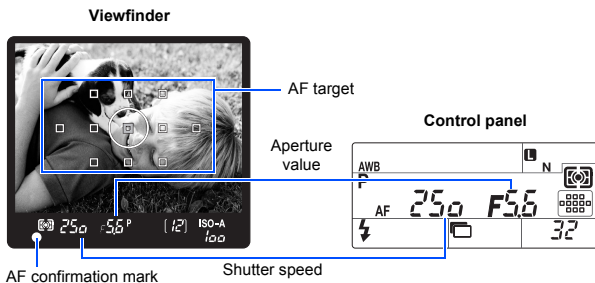

- The focus is locked when a beep tone is output. The AF confirmation mark and the AF target in focus light up in the viewfinder.
- The shutter speed and aperture value that have been set automatically by the camera are displayed.
- The super control panel is not displayed when the shutter button is pressed.

- 3 Release the shutter

Press the shutter button all the way (fully).



- The shutter sounds and the picture is taken.
- The card access lamp blinks and the camera starts recording the picture.

Never remove the battery or card while the card access lamp is blinking. Doing so could destroy stored pictures and prevent storage of pictures you have just taken.



## Holding the camera

Keep your fingers and the strap away from the lens, flash, and the white balance sensor.



Horizontal grip



Vertical grip

## Taking a picture while viewing the monitor

It is possible to use the LCD monitor and check the subject's composition, or shoot while viewing an enlarged display on the LCD monitor.  "Using live view" (P. 31)

### 1 Press the (live view) button

- The subject is displayed on the LCD monitor.

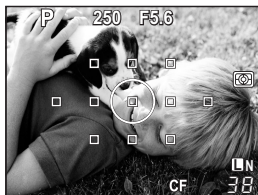

Shutter button

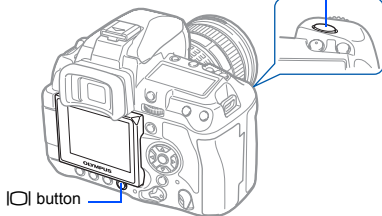

### 2 Press the shutter button all the way down

- The picture is taken with the focus adjusted.

## When the camera stops operating

If no operations are performed for approximately 8 seconds while the camera is on, the monitor backlight turns off to save battery power (when the super control panel is lit). If no operations are performed for approximately one minute thereafter, the camera enters the sleep mode (stand-by) and stops operating. The camera activates again when you touch any button (the shutter button, arrow pad, etc.).  "BACKLIT LCD (Backlight timer)" (P. 95), "SLEEP" (P. 94)

# Playback/Erasing

## Playing back images

Pressing the  button displays the last picture taken.

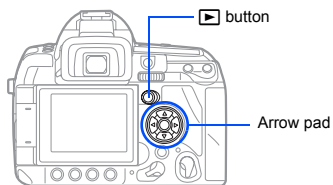

Displays the frame that is stored 10 frames back

Displays the previous frame



Displays the next frame



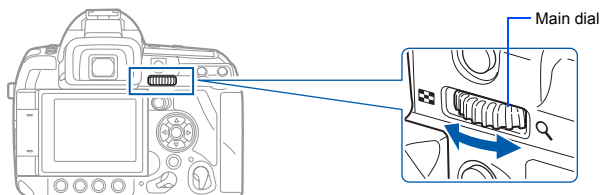

Displays the frame that is stored 10 frames ahead

## Close-up playback

Each time you turn the main dial towards , the image is incrementally enlarged from 2× to 14×.







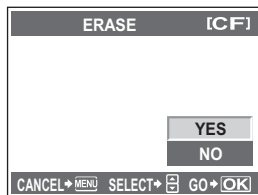
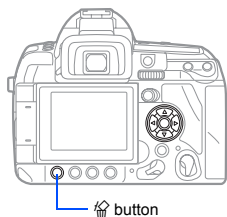

## Erasing images

Play back the image you want to erase and press the  button. Use   to select **[YES]** and press the  button to erase.



# Indications used in this manual

- In this manual,  indicates the main dial on the back of the camera.
- In this manual,  indicates the sub dial on the front of the camera.
- The operation button icons on the body of the camera are used to indicate the operation buttons in this manual. See "Names of parts and functions" ( P. 2).
- The following symbols are used throughout this manual.

 <b>Notes</b>	Important information on factors which may lead to a malfunction or operational problems. Also warns of operations that should be absolutely avoided.
 <b>TIPS</b>	Useful information and hints that will help you get the most out of your camera.
	Reference pages describing details or related information.

## To make the most of this manual

You can use the "Table of Contents" (P. 20) or "Index" (P. 151) as well as the following reference to search for information on camera functions and operations. Use this manual according to shooting conditions and to find the desired information.

For information on the possible shooting functions:

 "Shooting guides" (P. 34)

For information on how to operate the camera:

 "Using the direct buttons" (P. 27)

"Using the super control panel" (P. 28)

"Using the menu" (P. 29)

To search for a function from a list:

 "Menu directory" (P. 135)

"Index" (P. 151)

# Table of Contents

## Basic guide

2

Identifies the camera part names and describes the basic steps for shooting and playback.

Names of parts and functions .....	2
Camera .....	2
Direct buttons .....	4
Viewfinder .....	5
Control panel .....	6
Super control panel .....	7
LCD monitor (Live view) .....	8
LCD monitor (Playback) .....	9
Unpack the box contents .....	10
Preparations for shooting .....	11
Preparing the battery .....	11
Attaching a lens to the camera .....	12
Loading the card .....	13
Power on .....	14
Setting the date/time .....	15
Shooting .....	16
Playback/Erasing .....	18
Indications used in this manual .....	19

## 1 Basic camera operations

26

Describes the basic operations of the camera.

Using the direct buttons .....	27
Using the super control panel .....	28
Using the menu .....	29
Using live view .....	31
Switching the information display .....	32
Enlarged display operation .....	32
Resetting to the factory default settings .....	33

## 2 Shooting guides — Improving your shooting skills

34

Describes shooting methods for various shooting situations.

Basic function guides .....	34
Focus — Operating the shutter button .....	34
Brightness — Exposure compensation .....	34
Color — White balance .....	35
Convenient settings — Customizing functions .....	35
A guide to functions for different subjects .....	36
Taking landscape pictures .....	36
Taking flower pictures .....	37
Taking night scene pictures .....	38

### 3 Exposure

40

Describes functions related to exposure, which is important for shooting. These functions are for determining the aperture value, shutter speed, and other settings by measuring the brightness in the picture.

Program shooting .....	40
Aperture priority shooting .....	41
Shutter priority shooting.....	42
Manual shooting .....	43
Bulb shooting.....	44
My Mode shooting .....	44
Under water wide/macro shooting .....	44
Preview function .....	45
Changing the metering mode .....	45
Exposure compensation .....	46
AE lock .....	47
AE bracketing .....	48
ISO sensitivity setting .....	49
ISO bracketing.....	50

### 4 Focusing and shooting functions

51

Describes the optimal focusing methods according to the subject and shooting conditions.

AF mode selection.....	51
S-AF (single AF).....	51
C-AF (continuous AF).....	52
MF (manual focus) .....	52
Simultaneous use of S-AF mode and MF mode (S-AF+MF) .....	53
Simultaneous use of C-AF mode and MF mode (C-AF+MF) .....	53
AF target selection.....	53
Registering an AF target mode .....	55
Focus lock — If correct focus cannot be obtained .....	55
Sequential shooting .....	56
Self-timer shooting.....	57
Remote control shooting.....	58
Anti-shock.....	59
Image stabilizer .....	60
Checking the image stabilizer effect with live view.....	60

### 5 Record mode, white balance, and picture mode

61

Describes image adjustment functions specific to digital cameras.

Selecting the record mode.....	61
Recording formats .....	61
Selecting the record mode .....	62

Selecting the white balance.....	62
Setting the auto/preset/custom white balance .....	63
WB compensation .....	64
Setting the one-touch white balance .....	65
WB bracketing .....	66
Picture mode .....	67
Gradation.....	68
Noise reduction.....	69
Noise filter.....	69

## 6 Flash shooting

70

Describes how to shoot with the built-in flash and an external flash.

Flash mode setting .....	70
Built-in flash shooting .....	73
Flash intensity control.....	73
Flash bracketing .....	74
External flash shooting .....	74
Using the external electronic flash .....	75
Super FP flash .....	76
Shooting with the Olympus wireless RC flash system.....	76
Using commercially available flashes .....	77
Non-specified commercial flashes .....	78

## 7 Playback functions

79

Describes the functions for image playback.

Single-frame/Close-up playback.....	79
Light box display.....	80
Index display/Calendar display.....	81
Information display .....	82
Slideshow .....	83
Rotating images.....	83
Playback on TV .....	84
Editing still images.....	84
Copying images.....	85
Protecting images.....	86
Erasing images.....	87





## 8 Customizing your camera

90

Describes how to customize the camera's settings.

Custom Menu 1 .....	90
<b>AF</b> AF/MF .....	90
AF ILLUMINAT.....	90
FOCUS RING.....	90
C-AF LOCK.....	90
AF AREA POINTER.....	90

	AF SENSITIVITY .....	90
	SET UP .....	91
	RESET LENS .....	91
	BULB FOCUSING .....	91
<b>18</b>	BUTTON/DIAL .....	91
	DIAL .....	91
	AEL/AFL .....	92
	AEL/AFL MEMO .....	92
	FUNCTION .....	92
	MY MODE SETUP .....	93
	BUTTON TIMER .....	94
	.....	94
<b>1c</b>	RELEASE/ .....	94
	RLS PRIORITY S/RLS PRIORITY C .....	94
	L fps .....	94
<b>1d</b>	DISP//PC .....	94
	.....	94
	SLEEP .....	94
	BACKLIT LCD (Backlight timer) .....	95
	4 h TIMER (Auto power off) .....	95
	USB MODE .....	95
	LIVE VIEW BOOST .....	95
	FRAME ASSIST (Ruled lines display) .....	95
<b>1e</b>	EXP//ISO .....	96
	EV STEP .....	96
	ISO STEP .....	96
	ISO-AUTO SET .....	96
	ISO-AUTO .....	96
	AELMetering .....	96
	BULB TIMER .....	96
<b>1f</b>	CUSTOM .....	96
	X-SYNC. ....	96
	SLOW LIMIT .....	96
	.....	96
<b>1g</b>	-/COLOR/WB .....	97
	ALL  .....	97
	COLOR SPACE .....	97
	SHADING COMP. ....	97
	SET .....	97
	PIXEL COUNT .....	98
<b>1h</b>	RECORD/ERASE .....	98
	QUICK ERASE .....	98
	RAW+JPEG ERASE .....	98
	FILE NAME .....	98
	PRIORITY SET .....	99
	dpi SETTING .....	99

  UTILITY .....	99
EXT. WB DETECT .....	99
Custom Menu 2 .....	99
CF/xD .....	99
EDIT FILENAME .....	99
 (Monitor brightness adjustment) .....	99
 (Changing the display language) .....	100
VIDEO OUT .....	100
REC VIEW .....	100
FIRMWARE .....	100

## 9 Printing

101

Describes how to print your pictures.

Print reservation (DPOF) .....	101
Print reservation .....	101
Single-frame reservation .....	101
All-frame reservation .....	102
Resetting the print reservation data .....	102
Direct printing (PictBridge) .....	103
Connecting the camera to a printer .....	104
Easy printing .....	104
Custom printing .....	105

## 10 Using the OLYMPUS Master software

107

Describes how to transfer and store your camera images to a computer.

Flowchart .....	107
Using the provided OLYMPUS Master software .....	107
What is OLYMPUS Master? .....	107
Connecting the camera to a computer .....	108
Start up the OLYMPUS Master software .....	109
Displaying camera images on a computer .....	109
Downloading and saving images .....	109
Disconnecting the camera from your computer .....	110
Viewing still images .....	111
To increase the number of languages .....	111
Transferring images to your computer without using OLYMPUS Master .....	112

## 11 Shooting tips and maintenance

113

Refer to this section for troubleshooting and camera maintenance information.

Shooting tips and information .....	113
Tips before you start taking pictures .....	113
Shooting tips .....	113
Additional shooting tips and information .....	116
Playback tips .....	117
Viewing pictures on a computer .....	118



Error codes .....	118
Camera maintenance .....	121
Cleaning and storing the camera .....	121
Cleaning mode — Removing dust .....	122
Pixel mapping — Checking the image processing functions .....	122

## 12 Information

123

Refer to this section for information on optional accessories, camera specifications, and other useful shooting information.

Main optional accessories .....	123
Card basics .....	124
Usable cards .....	124
Formatting the card .....	125
Battery and charger .....	125
AC adapter .....	125
Using your charger abroad .....	126
Interchangeable lenses .....	126
ZUIKO DIGITAL interchangeable lens .....	126
ZUIKO DIGITAL lens specifications .....	127
Program line diagram (P mode) .....	128
Flash synchronization and shutter speed .....	129
Exposure warning display .....	129
Flash distance .....	130
Vignetting of the built-in flash when using an interchangeable lens .....	130
Flash modes that can be set by shooting mode .....	131
White balance color temperature .....	132
Record mode and file size/number of storable still pictures .....	133
Functions that can be registered with My Mode and Custom Reset Setting .....	134
Menu directory .....	135
Glossary .....	139
Specifications .....	142
SAFETY PRECAUTIONS .....	145
Index .....	151

There are three basic ways to make function settings with this camera.

## Using the direct buttons to operate the camera P. 27

You can make the function settings by rotating the main dial or sub dial while pressing the direct buttons assigned to a function. This is useful for operating the camera while composing the subject in the viewfinder and for quickly operating the camera while checking the settings on the control panel.

## Setting while looking at the super control panel P. 28

You can make the function settings with the super control panel on the LCD monitor. You can use the super control panel to view the current settings and directly change the settings.

## Setting on the menu P. 29

You can use the menu to set shooting and playback settings and customize camera functions.

## Descriptions in this manual

---

The operating instructions of the direct buttons, super control panel and menu are described as follows in this manual.

- “+” indicates operations performed at the same time.
- “▶” indicates you should proceed to the next step.

e.g.: When setting the metering mode

### Direct button



### Super control panel



### Menu



## Using the direct buttons

There are two ways to use the direct buttons.

**While holding down a direct button, turn the main dial or sub dial.**

- Release the button to set the function.
- Some functions are set using only the main dial (or sub dial).

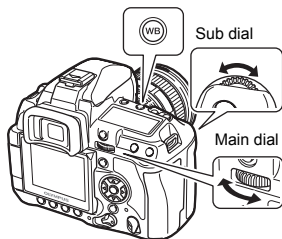

- The three buttons next to the flash have two functions each. Use the main dial to operate and set the functions indicated above the buttons, and use the sub dial to operate and set the functions indicated to the side of the buttons.

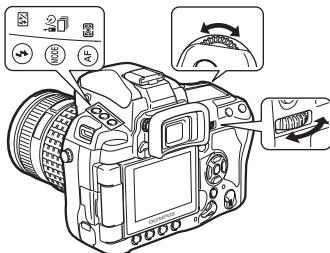

**After pressing two direct buttons at the same time, turn the main dial or sub dial.**

- When the buttons are pressed, the corresponding function is selected. The function remains selected for approximately 8 seconds. You can turn the dial and set the function during that time. If no operations are performed during that time, the setting for that function is then set.

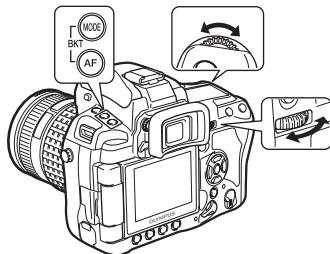

Setting information is displayed in the viewfinder and on the control panel and super control panel while you are setting a function. (The setting with the /AF button is shown in the screenshots.)

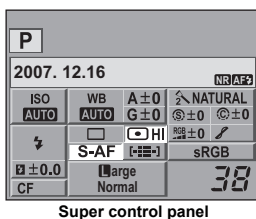
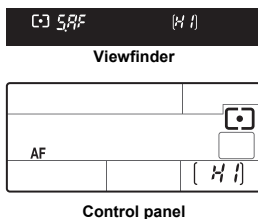

**TIPS**

If you find it difficult to turn the dial while holding down a direct button:

→ The button may remain selected even after it is released. "BUTTON TIMER" (P. 94)

For details on the functions that can be set with the direct buttons, refer to "Direct buttons" ( P. 4).

**1**

Basic camera operations

## Using the super control panel

Select an item on the super control panel and change the setting.

**1 Press the **INFO** button to display the super control panel on the LCD monitor.**

- Press the **INFO** button again to turn off the super control panel.
- Press the button during live view to display the super control panel.

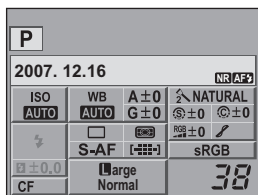
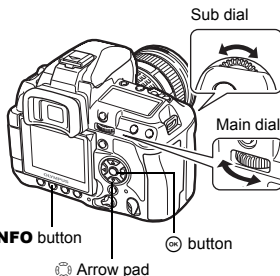

**2 Press the button.**

- The cursor on the super control panel lights.

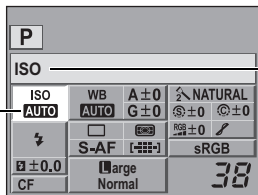



Cursor

The name of the selected function is displayed.

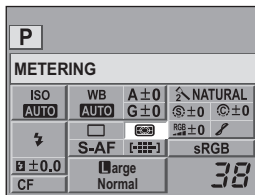
**3 Use to move the cursor to the function you want to set.**



#### 4 Use the main dial or sub dial to change the setting.

- Press the  button to display the direct menu indicated at the position of the cursor. You can also use the direct menu to change the setting. After changing the setting, press the  button to confirm your setting. If no operation is made within a few seconds, your setting is confirmed and the super control panel is displayed.
  -  "BUTTON TIMER" (P. 94)

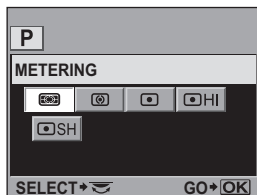

Direct menu

For details on the functions that can be set with the super control panel, refer to "Super control panel" ( P. 7).

## Using the menu





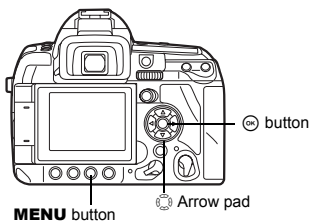
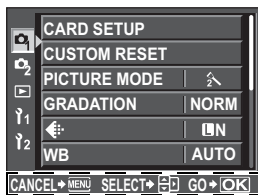

### 1 Press the **MENU** button.





- The menu is displayed on the LCD monitor.



Operation guide is displayed at the bottom of the screen.

**CANCEL**  **MENU**  : Press the **MENU** button to cancel the setting.

**SELECT**    : Press     on the arrow pad to move the cursor and select an item. The symbols displayed on the LCD monitor correspond to the arrow pad shown below.

    : Press the  button to confirm your settings.

**2** Use to select a tab and to set an item.

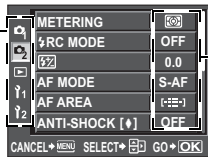

Tab The current setting is displayed

**3** Use to select a function and to go to the setting screen.

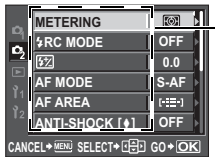

Function

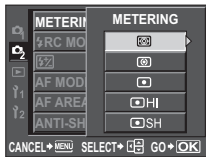

**Types of tabs**

- Sets shooting functions.
- Sets shooting functions.
- Sets playback functions.
- Customizes shooting functions. Depending on the function being customized, the function is further separated into 9 tabs (A to I).
- Sets the basic functions of the camera.

**Screenshot of menu with the tab selected**

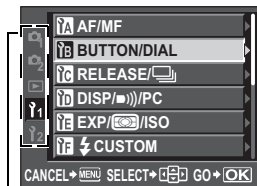

Tab

**4** Press the button to confirm your settings.

- Press the button repeatedly to exit the menu.

**Using the dials to select a menu**

- In addition to using the arrow pad, you can also use the dials to select a function. Turn the main dial to move the cursor vertically (the same as pressing ) and turn the sub dial to move the cursor horizontally (the same as pressing ).

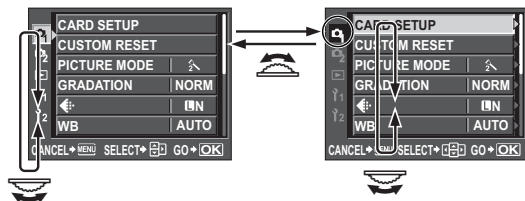

- Selecting a function and rotating the main dial automatically changes the tab and allows you to select a function on the next tab.

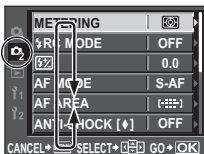

- You can change the operations of the main dial and sub dial. "DIAL" (P. 91)

For details on the functions that can be set with the menu, refer to "Menu directory" ( P. 135).



It is possible to use the LCD monitor as a viewfinder. You can view the exposure or white balance effect and the subject's composition while you take the picture.

Close the eyepiece shutter so the light entering through the viewfinder does not affect the exposure while shooting with live view. “Eyepiece shutter” (P. 58)

### 1 Press the button.

- The mirror is raised and the subject is displayed on the LCD monitor.
- The screen prompting you to close the eyepiece shutter is displayed.

### 2 Press the shutter button all the way to take a picture.

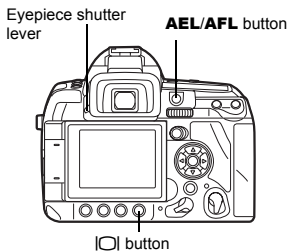

### Focusing during live view

- When you press the shutter button all the way during live view, the focus is locked and a picture is taken. The image display on the monitor freezes as the mirror goes down during focusing.
- To focus in advance, hold down the **AEL/AFL** button and press the shutter button. When the focus is locked, the AF confirmation mark lights up. When the AF confirmation mark is blinking, the focus is not locked.
- When the AF mode is set to S-AF, the picture cannot be taken until the focus is locked.
- In MF mode, you can press the **AEL/AFL** button to activate the auto focus.

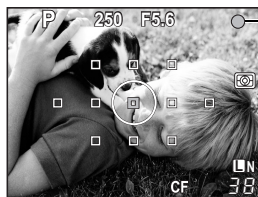

AF confirmation mark

### Shooting while changing the angle of the LCD monitor

You can change the angle of the LCD monitor on the camera. This enables you to shoot at an awkward angle while checking the subject's composition on the LCD monitor.

- Slowly rotate the LCD monitor within the moveable range.

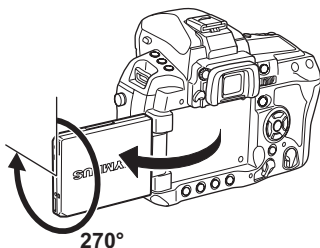

## Switching the information display

You can switch the information displayed on the monitor by pressing **INFO** button repeatedly.

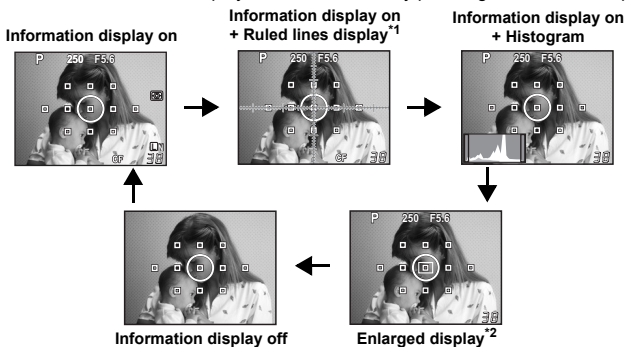

\*1 Displayed when [FRAME ASSIST] is set. "FRAME ASSIST (Ruled lines display)" (P. 95)

\*2 For operation in the enlarged display, refer to "Enlarged display operation".

## Enlarged display operation

It is possible to enlarge the subject for display. Enlarging the image during MF makes focus confirmation and adjustment easier.

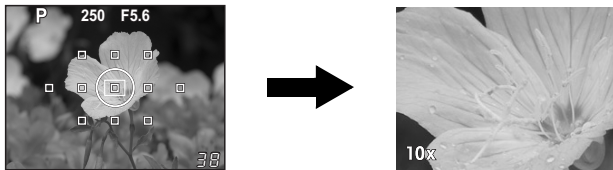

- 1 Use to move the frame and press the button.
  - Area inside the frame is enlarged and displayed.
  - Press and hold the button to return the shifted enlargement frame to the center.
- 2 Turn the main dial (or sub dial) to change the magnification (5x/7x/10x).
  - Pressing the button cancels enlarged display operation.

### TIPS

#### Checking the image stabilizer effect:

→ Press and hold the IS button. "Checking the image stabilizer effect with live view" (P. 60)

#### Checking the subject on the monitor even in low light situations:

→ See "LIVE VIEW BOOST" ( P. 95).

### Notes

- If there is a high-intensity light source within the screen, the image may be displayed darker but will be recorded normally.
- If the live view function is used over a long period, the temperature of the image pickup device rises causing images with high ISO sensitivity to appear noisy and unevenly colored. Either lower the ISO sensitivity or turn off the camera for some time.
- Exchanging the lens will cause live view to stop.
- The following functions are not available during live view.
  - C-AF/AE lock/[AEL/AFL]



## Resetting to the factory default settings

Normally, current camera settings (including any changes you have made) are retained when the power is turned off. To reset the camera to the factory default settings, set **[RESET]**. You can register settings in advance to **[RESET1]** and **[RESET2]**. The camera settings at that time are registered in **[RESET1]** and **[RESET2]**. For details on the registered functions, refer to "Functions that can be registered with My Mode and Custom Reset Setting" (P. 134).

### Registering **[RESET1]**/**[RESET2]**

#### Menu

**MENU** > **[Q]** > **[CUSTOM RESET]**

- 1 Select either **[RESET1]**/**[RESET2]** to register and press **[M]**.
  - If settings have already been registered, **[SET]** is displayed next to **[RESET1]**/**[RESET2]**. Selecting **[SET]** again overwrites the registered setting.
  - To cancel the registration, select **[RESET]**.
- 2 Select **[SET]** and press the **[OK]** button.

### Using reset settings

You can reset the camera to **[RESET1]** or **[RESET2]** setting or restore the factory default settings.

**[RESET]** : Resets to the factory default settings. For the default settings, see "Menu directory" (P. 135).

**[RESET1]**/**[RESET2]** : Resets to the registered settings.

#### Direct button

**[M] + ISO**

- Holding down the **[M]** button and **ISO** button at the same time for 2 seconds performs **[RESET]**.
- While pressing two buttons at the same time, turn the dial to select the reset setting. Release the button to reset the settings.



Viewfinder

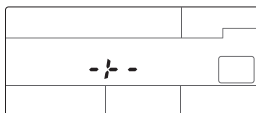

Control panel

**[M]** : RESET  
**[M]** / **[ISO]** : RESET1  
**[M]** / **[ISO]** : RESET2

#### Menu

**MENU** > **[Q]** > **[CUSTOM RESET]**

- 1 Select **[RESET]**, **[RESET1]**, or **[RESET2]** and press the **[OK]** button.
- 2 Use **[←]**/**[→]** to select **[YES]**, then press the **[OK]** button.

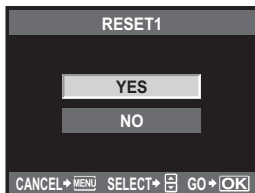

## Basic function guides

To familiarize yourself with the camera, you can start off by taking pictures of surrounding subjects, such as children, flowers and pets. If the pictures taken are not to your liking, try adjusting some of the settings below. You can take more satisfying pictures simply by familiarizing yourself with these basic camera functions.

### Focus — Operating the shutter button

A picture can become out of focus when the focus in the picture is on the foreground, background, or other objects in the picture instead of on the subject. To prevent out-of-focus pictures, be sure to focus on the subject you are trying to capture. The shutter button can be pressed halfway down (half-press) and all the way down (full press). Once you are able to operate the shutter button effectively, you can focus accurately even on moving subjects.



☞ “Shooting” (P. 16), “Focus lock — If correct focus cannot be obtained” (P. 55)

Even when the subject is in focus, the picture can become blurred if you move the camera while the shutter button is being pressed. This is called “camera shake”. Make sure how to properly hold the camera. The camera is particularly subject to shaking when using live view to take pictures while viewing the subject on the monitor. You can reduce camera shake by using the image stabilizer.

☞ “Holding the camera” (P. 17), “Image stabilizer” (P. 60)

In addition to incorrect focusing and camera shake, movement of the subject can also cause blurring of the picture. In this case, use a shutter speed that matches the motion of the subject. You can confirm the actual shutter speed and aperture on the displays of the viewfinder, control panel, and monitor by pressing the shutter button halfway.

☞ “Viewfinder” (P. 5), “Control panel” (P. 6), “Super control panel” (P. 7), “LCD monitor (Live view)” (P. 8)

### Brightness — Exposure compensation

The camera automatically determines the aperture value and shutter speed according to the brightness level. This is called auto exposure. However, you may not be able to capture the intended picture with auto exposure alone. In this case, you can increase or decrease the auto exposure setting. Increase the exposure to enhance the brightness of a summer beach or the whiteness of snow. Decrease the exposure when the area to be shot is brighter but smaller compared to its surrounding area. If you are unsure of how much exposure compensation is required, try taking several pictures at various settings and then compare the pictures.

☞ “Exposure compensation” (P. 46), “AE bracketing” (P. 48)



## Color — White balance

Besides sunlight, there are other sources for illuminating the subject, such as tungsten and fluorescent lighting. These types of lighting contain particular colors; therefore, the same white object shot under different lighting has slightly different colors. Even under the same sunlight, the colors in the picture differ depending on the sky conditions, the shadows of trees or buildings, and other factors. White balance automatically corrects the effects from these types of lighting and enables shooting with the right colors. You can usually obtain the right colors with the white balance set to **[AUTO]**. Depending on the shooting conditions, however, you may not be able to obtain the intended colors. In this case, change the setting accordingly.

 "Selecting the white balance" (P. 62)

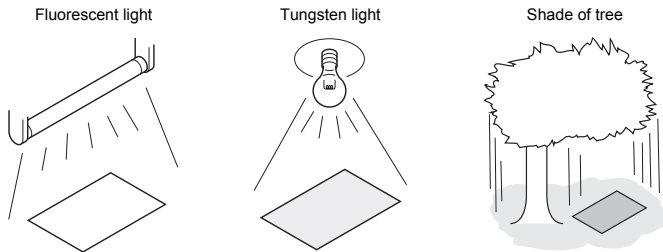

## Convenient settings — Customizing functions

This camera is equipped with various shooting functions that can be customized for ease of use.

For example, if you want to take several pictures of the same subject using the same settings, you can register those settings as My Mode for use at a later time. You can then easily load that registered My Mode and use it as the shooting mode.

To focus on the subject and then recompose the shot, you can set **[AEL/AFL]** so that auto focus can be done by pressing the **AEL/AFL** button, and then you can lock the exposure by pressing the shutter button halfway.

You can customize other camera operations, such as by changing the functions assigned to the dials and the **Fn** button and by changing the time that the direct buttons remain selected.

 "MY MODE SETUP" (P. 93), "My Mode shooting" (P. 44), "AEL/AFL" (P. 92), "**Fn** FUNCTION" (P. 92), "BUTTON TIMER" (P. 94)

## A guide to functions for different subjects

This section describes the functions suitable under different shooting conditions depending on the subject.

### Taking landscape pictures

This section describes how to take outdoor scenery pictures of forests, lakes and beaches in daylight.

#### Changing shooting mode

The proper shooting method varies depending on whether you are trying to capture the silence of a still scene or the dynamism of a motion scene.

- To capture the depth of a forest, focus with a wider range of the image. Use **A** (aperture priority shooting) mode and close the aperture (increase the aperture value) as much as possible.
- To capture the waves crashing against the seashore, use **S** (shutter priority shooting) mode and select a fast shutter speed. To capture a flowing waterfall or river, shoot using a slow shutter speed.

Exposure compensation can be used even under different shooting modes. Check the image that you have shot and use + or - to adjust the exposure to obtain better results.



#### Changing white balance

The color of water in pictures appears different depending on whether it is a lake reflecting nearby trees or a seashore surrounded by a coral reef. To capture the subtle difference in color, try changing the white balance setting. Change the setting for different situations, such as by using [☀️:5300K] for sunny days and [🏠:7500K] for outdoor shaded areas on sunny days.



#### Changing metering mode

Depending on the depth of the water and the direction of the sun, the brightness of the water can differ significantly in different areas of the same composition. There is also a difference in the brightness of forests depending on the way the trees overlap each other. If you know which areas you want to emphasize the compensation in the image composition, you can change the metering mode. When set to [☀️] (Digital ESP metering), the camera automatically assesses the brightness in the composition and determines the exposure. To emphasize a specific partial exposure in the composition, change the metering mode to [👤] (center weighted metering) or [📍] (spot metering), adjust the metering area to the locations that you want to adjust the exposure and then measure the exposure.

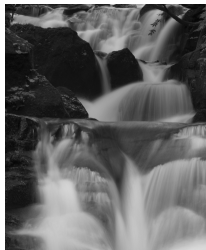

## Changing saturation

There may be times when you cannot reproduce the desired color even when using white balance or exposure compensation. In this case, you can change the **[SATURATION]** setting to achieve the desired color. The **[SATURATION]** setting includes two levels of high and low settings. When the setting is high, a vivid color is used.

☞ “Aperture priority shooting” (P. 41), “Shutter priority shooting” (P. 42), “Changing the metering mode” (P. 45), “Exposure compensation” (P. 46), “Selecting the white balance” (P. 62), “[SATURATION] : Vividness of the color” (P. 67)

## Taking flower pictures

The proper method for taking pictures of flowers differs depending on whether you want to capture, for example, a single flower, a field of blooming flowers, a deep red rose, or the light color of a sweet pea.

### Changing the AF sensitivity

You can narrow the range of focus, for example, so as to focus on a single flower petal or focus on a single flower in a field of flowers.

The default setting enables the camera to focus on an area larger than the selected AF target, but depending on the **[AF SENSITIVITY]** setting, the camera may focus only on the selected AF target.

### Changing white balance

There are many colors of flowers ranging from light to vivid ones. Depending on the colors of the flowers, subtle color shades may not be captured as seen. In this case, you can check the light conditions and change the white balance setting. At **[AUTO]**, the camera automatically determines the type of light and shoots using the proper white balance. However, you can bring out subtle color shades more effectively by changing the setting according to shooting conditions, such as by using **[☀️ 5300K]** for sunny days and **[☁️ 7500K]** for outdoor shaded areas on sunny days.



### Using exposure compensation

When shooting flowers against a background, select as simple a background as possible to bring out the shape and color of the flower. When shooting bright and whitish flowers, adjust the exposure compensation to – (minus) so that the flower stands out from the darker background.



## Changing shooting mode

The proper shooting method when taking pictures of flowers differs depending on whether you want to emphasize a single flower or capture a field of flowers. To change the focus area, set the camera to **A** (aperture priority shooting) mode and select the aperture value.

- When you open the aperture (decrease the aperture value), the camera focuses within a shorter range (with a shallow depth of field), emphasizing the subject against a blurred background.
- When you close the aperture (increase the aperture value), the camera focuses over a wider range (with more depth of field), producing a picture with both the foreground and background in focus.

You can use the preview function to confirm the changes in the depth of field when the aperture is changed.



## Using live view

When using a conventional digital single-lens reflex camera with interchangeable lens system, it was necessary to wait until after taking the picture to check the results of the exposure compensation and white balance settings. With the live view function of this camera, however, you can use the monitor to display and check the subject you want to capture.

## Changing lenses

When the blooming flowers are few and sparse, take the picture using a telephoto lens. With a telephoto lens, you take pictures in which subjects at different distances appear closer together, giving the impression of a more densely blooming flower field. Using the telescopic feature of the zoom lens also achieves the same effect, but it is easier to achieve this effect when the focal distance of the lens is longer, such as 150 mm or 200 mm, rather than 54 mm.

☞ “AF SENSITIVITY” (P. 90), “Aperture priority shooting” (P. 41), “Using live view” (P. 31), “Preview function” (P. 45), “Exposure compensation” (P. 46), “Selecting the white balance” (P. 62)

## Taking night scene pictures

There are different types of night scenes, from the afterglow of a sunset and city lights at night to special light displays and firework displays.

## Using a tripod

Because a slow shutter speed is needed to capture night scenes, a tripod is required to prevent camera shake. If a tripod is not available, you should place the camera on a stable surface to prevent camera shake. Even if the camera is secured, camera shake may occur when pressing the shutter button. Therefore, it is recommended to use the remote control or self timer.



## Changing shooting mode

Night scenes have different levels of brightness, and the balance of the brightness in the composition is not uniform. Start by using **A** (aperture priority shooting) mode to take the picture. Set the aperture to the medium setting (about F8 or F11) and allow the camera to automatically select the shutter speed. When shooting a night scene, because the camera sets the exposure to match the dark areas which occupy a majority of the composition and the image often turns out whitish (overexposed), adjust the exposure compensation to -1 or -1.5. Use **[REC VIEW]** to check the image and adjust the aperture and exposure compensation as necessary.

Image noise can easily occur when shooting at slow shutter speeds. In this case, set **[NOISE REDUCT.]** to **[ON]** to reduce noise.

## Using manual focus

In cases where you cannot use AF (auto focus) to focus on the subject because the subject is too dark or you cannot focus in time to take pictures, such as during a fireworks display, set the AF mode to **[MF]** (manual focus) and focus manually. To take pictures of night scenes, turn the focus ring of the lens and check whether you can see the lights of the night scene clearly. To take pictures of a fireworks display, adjust the focus of the lens to infinite unless you are using a long focus lens. If you know the approximate distance to the subject, it is recommended that you focus on something that is at the same distance in advance.

☞ “Program shooting” (P. 40), “Aperture priority shooting” (P. 41), “Remote control shooting” (P. 58), “AF mode selection” (P. 51), “Noise reduction” (P. 69), “REC VIEW” (P. 100)



## Program shooting

P

The camera sets the optimum aperture value and shutter speed automatically according to the subject brightness.

### Direct button

**MODE +**  **[P]**

- When the shutter button is half-pressed, the shutter speed and aperture value are displayed on the viewfinder and control panel.

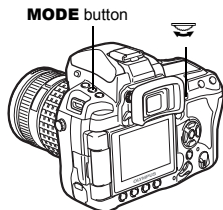

3

Exposure

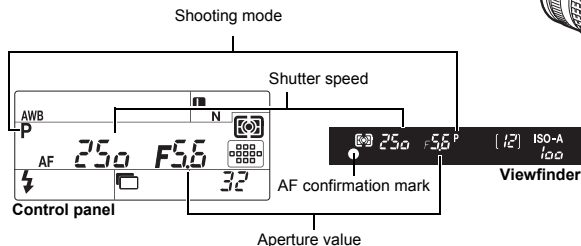

### Program shift (Ps)

By turning the main dial (or sub dial) in the **P** mode, you can change the combination of aperture and shutter speed while maintaining the optimum exposure.  "Program line diagram (**P** mode)" (P. 128)

- The program shift setting will not be canceled after shooting. To cancel program shift setting, turn the main dial (or sub dial) until the shooting mode indication **Ps** on the viewfinder or control panel changes to **P** or turn off the power.
- Program shift is not available when you are using a flash.

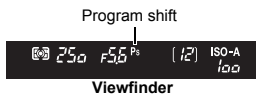

### TIPS

#### The shutter speed and aperture value are blinking:

→ The optimum exposure cannot be obtained. For details, see "Exposure warning display" ( P. 129).

#### When you want to change the shooting mode using only your right hand:

→ You can change the shooting mode using the **Fn** button and dials.  "Fn FUNCTION" (P. 92)



## Aperture priority shooting

**A**

The camera sets the optimum shutter speed automatically for the aperture value you have selected. When you open the aperture (decrease the aperture value), the camera will focus within a shorter range (shallow depth of field) and produce a picture with a blurred background. When you close the aperture (increase the aperture value), the camera will focus within a longer range. Use this mode when you wish to add changes to the background representation. Before shooting, you can use the preview function to check how the background will look in your picture.  "Preview function" (P. 45)

When the aperture value (f-number) is decreased



When the aperture value (f-number) is increased

### Direct button

**MODE +  [A]**

- Turn the main dial (or sub dial) to set the aperture value.

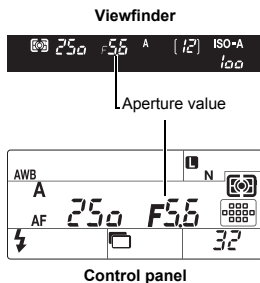

Open the aperture (f-number is decreased)

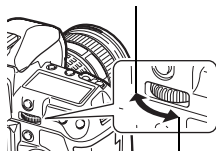

Close the aperture (f-number is increased)

### TIPS

**To check the depth of field with the selected aperture value:**

→ See "Preview function" ( P. 45).

**To change the exposure adjustment interval:**

→ This can be set in 1/3 EV, 1/2 EV or 1 EV increments.  "EV STEP" (P. 96)

**Shutter speed is blinking:**

→ The optimum exposure cannot be obtained. For details, see "Exposure warning display" ( P. 129).

**3****Exposure**

## Shutter priority shooting

**S**

The camera sets the optimum aperture value automatically for the shutter speed you have selected. Set the shutter speed depending on the type of effect you want. A higher shutter speed allows you to capture a fast-moving subject without blur, and a slower shutter speed blurs a moving subject, creating a feeling of speed or motion.

A fast shutter speed can freeze a fast action scene without any blur.



A slow shutter speed will blur a fast action scene. This blurring will give the impression of dynamic motion.

**3**

Exposure

**Direct button****MODE +**  **[S]**

- Turn the main dial (or sub dial) to set the shutter speed.

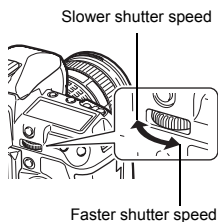
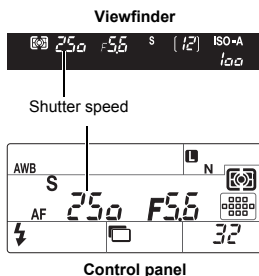
**TIPS****The picture looks blurred:**

→ The possibility of camera shake spoiling your picture increases greatly during macro or ultra-telephoto shooting. Raise the shutter speed or use a monopod or tripod to stabilize the camera.

**To change the exposure adjustment interval:**

→ This can be set in 1/3 EV, 1/2 EV or 1 EV increments.  "EV STEP" (P. 96)

**The aperture value is blinking:**

→ The optimum exposure cannot be obtained. For details, see "Exposure warning display" ( P. 129).

Allows you to set the aperture and shutter speed manually. You can check how much it differs from the appropriate exposure by using the exposure level indicator. This mode gives you more creative control, allowing you to make whatever settings you like, regardless of the correct exposure.

**Direct button****MODE +**  **[M]**

To set the aperture value: Turn the main dial.

To set the shutter speed: Turn the sub dial.

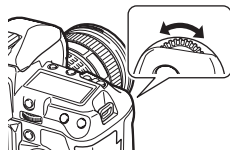

- The range of aperture values available varies with the lens type.
- The shutter speed can be set from 1/8000 to 60 sec.
- The exposure level indicator is displayed in **M** mode, showing the difference (ranging from -3 EV to +3 EV) between the exposure value calculated by the currently selected aperture and shutter speed compared to the exposure value considered optimum by the camera. If the exposure value exceeds  $\pm 3$  EV, the entire indicator blinks.

**Noise in images**

During shooting at slow shutter speeds, noise may appear on-screen. These phenomena are caused when current is generated in those sections of the image pickup device that are not normally exposed to light, resulting in a rise in temperature in the image pickup device or image pickup device drive circuit. This can also occur when shooting with a high ISO setting in a high-temperature environment. To reduce this noise, the camera activates the noise reduction function.

 "Noise reduction" (P. 69)

**TIPS****The picture looks blurred:**

→ The use of a monopod or tripod is recommended when taking a picture at slow shutter speed.

**To change the exposure adjustment interval:**

→ This can be set in 1/3 EV, 1/2 EV or 1 EV increments.  "EV STEP" (P. 96)

**To switch the operations of the main dial and sub dial:**

→ You can switch the functions that are set with the main dial and sub dial.  "DIAL" (P. 91)

**Notes**

- Exposure compensation is not available in **M** mode.

## Bulb shooting

**B**

You can take a picture with a bulb exposure time in which the shutter stays open as long as you hold down the shutter button.

Bulb shooting can also be done using an optional remote control (RM-1) or remote control cable (RM-CB1). "Bulb shooting with the remote control" (P. 59)

### Direct button

**MODE** + ▶ **[B]**

- "buLb" is displayed in the viewfinder and on the control panel.

bulb

### TIPS

**To automatically end bulb shooting after a specified period of time:**

→ You can set the maximum time for bulb shooting. "BULB TIMER" (P. 96)

**To fix the focus during manual focus shooting:**

→ You can fix the focus so the focus does not change even if the focus ring is turned during exposure. "BULB FOCUSING" (P. 91)

### Notes

- The following functions are not available in **B** mode.  
Image stabilizer/sequential shooting/self-timer shooting/AE bracket shooting/flash bracket shooting

## My Mode shooting

You can take pictures using the camera settings registered in the **[MY MODE SETUP]**. This allows you to register two different combinations of camera settings to both **[MY MODE1]** and **[MY MODE2]**. "MY MODE SETUP" (P. 93)

### Direct button

**MODE** + ▶ **[M1]/[M2]**

### Setting display

When **P** is assigned to When **S** is assigned to 

## Under water wide/macro shooting

This camera has optimal shooting settings for underwater shooting. (under water wide) is suitable for shooting underwater landscapes, and (under water macro) is suitable for shooting up close underwater.

To shoot using under water wide or under water macro, you must set **[Fn FUNCTION]** to **[/]**. "Fn FUNCTION" (P. 92)

### Direct button

**MODE** + ▶ **[/]**

### Setting display



When set to



When set to

## ! Notes

- To use the camera for underwater shooting, attach a commercially available underwater case.
- The following functions are not available in [CUSTOM RESET]/[PICTURE MODE]/[MY MODE SETUP]

## Preview function

The viewfinder shows the focused area (depth of field) with the selected aperture value.

Press the preview button to use the preview function.

- You can also use the **Fn** button to use the preview function (factory default setting).
  - When [**Fn** FUNCTION] is assigned to [LIVE PREVIEW], pressing the **Fn** button automatically switches the camera to live view for a preview of the picture on the monitor.
- ➡ "Fn FUNCTION" (P. 92)

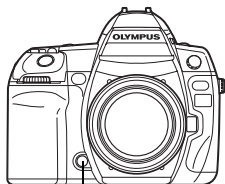

Preview button

3

Exposure

## Changing the metering mode



There are 5 ways to measure the subject brightness: Digital ESP metering, Center weighted averaging metering, and three types of spot metering. Select the most suitable mode for the shooting conditions.

### Direct button



### Super control panel



### Menu

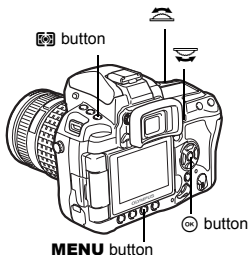

## Setting display



Viewfinder

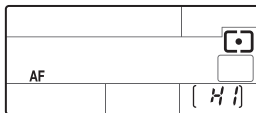

Control panel

- : Digital ESP metering
- : Center weighted averaging metering
- : Spot metering
- : Spot metering - highlight control
- : Spot metering - shadow control

### Digital ESP metering

The camera measures the light levels and calculates the light level differences in 49 separate areas of the image. This mode is recommended for general use. Setting the AF synchronized function to **[ESP+AF]** enables metering centered around the AF target that is in focus with AF.

### Center weighted averaging metering

This metering mode provides the average metering between the subject and the background lighting, placing more weight on the subject at the center. Use this mode when you do not want the light level of the background to affect the exposure value.

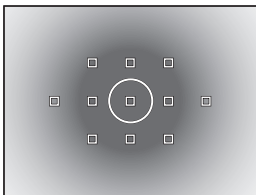

### Spot metering

The camera meters a very small area around the center of the subject, defined by the spot metering area mark in the viewfinder. Use this mode when there is very strong backlight.

### Spot metering - highlight control

When the overall background is bright, white areas of the image will come out gray if you use the camera's automatic exposure. Using this mode enables the camera to shift to over-exposure, allowing accurate white reproduction. Metering area is the same as spot metering.

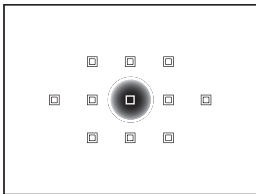

 : Metering area

### Spot metering - shadow control

When the overall background is dark, black areas of the image will come out gray if you use the camera's automatic exposure. Using this mode enables the camera to shift to under-exposure, allowing accurate black reproduction. Metering area is the same as spot metering.

## Exposure compensation

In some situations, you may get better results if you manually compensate (adjust) the exposure value set automatically by the camera. In many cases, bright subjects (such as snow) will turn out darker than their natural colors. Adjusting toward + makes these subjects closer to their real shades. For the same reason, adjust toward - when shooting dark subjects. The exposure can be adjusted in a range of  $\pm 5.0$  EV.



### Direct button

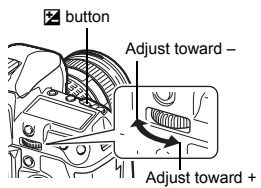

- The exposure compensation indicator is displayed. The exposure compensation indicator will not be displayed when the exposure is compensated by 0.

When set to 1/3 EV increments



When set to 1/2 EV increments

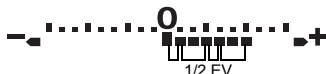

- If the exposure compensation value exceeds the scale of the exposure compensation indicator, the indicator will blink in the viewfinder and on the control panel. A red ◀▶ is displayed on the left and right edges of the indicator on the super control panel.



#### TIPS

#### To change the exposure adjustment interval:

→ The EV step interval can be selected from 1/3 EV, 1/2 EV or 1 EV. "EV STEP" (P. 96)

#### To adjust the exposure using only the dials:

→ You can set the exposure compensation value without pressing button. "DIAL" (P. 91)

#### Notes

- Exposure compensation is not available in **M** and **B** modes.

## AE lock

## AEL

The metered exposure value can be locked with the **AEL/AFL** button (AE lock). Use AE lock when you want a different exposure setting from the one that would normally apply under the current shooting conditions.

Normally, pressing the shutter button halfway locks both AF (auto focus) and AE (automatic exposure), but you can lock the exposure alone by pressing the **AEL/AFL** button.

**Press the AEL/AFL button at the position where you wish to lock the metering values and the exposure will be locked. The exposure is locked while the AEL/AFL button is pressed. Now press the shutter button.**

- Releasing the **AEL/AFL** button cancels AE lock.

#### TIPS

#### To lock the exposure:

→ You can lock the metering result so that it is not canceled when the **AEL/AFL** button is released. "AEL/AFL MEMO" (P. 92)

#### If you find it difficult to press the AEL/AFL button and shutter button at the same time:

→ You can switch the functions of the **AEL/AFL** button and the **Fn** button. "Fn" (P. 94)

#### To activate AE lock with a set metering mode:

→ You can set the metering mode for locking the exposure with the AE lock. "AEL Metering" (P. 96)

AEL/AFL button

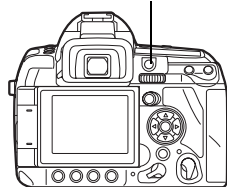

AE lock



Viewfinder

## AE bracketing

The camera automatically shoots a number of pictures at different exposure values for each frame. Even in conditions where correct exposure is difficult to obtain (such as a backlit subject or a scene at dusk), you can pick the picture you prefer from a selected number of frames with a variety of different exposure settings (exposure and compensation values). The pictures are taken in the following order: Picture with optimum exposure, picture adjusted in - direction, and picture adjusted in + direction.

e.g.) When BKT is set to [3F 1.0EV]



-1.0EV



±0



+1.0EV

3

Exposure

**Compensation value: 0.3, 0.7 or 1.0**



• The compensation value will change if the EV step is changed.  "EV STEP" (P. 96)

**Number of frames: 3 or 5**

**Direct button**

**MODE + AF**  

**Menu**

**MENU**   **[AE BKT]**

### Setting display

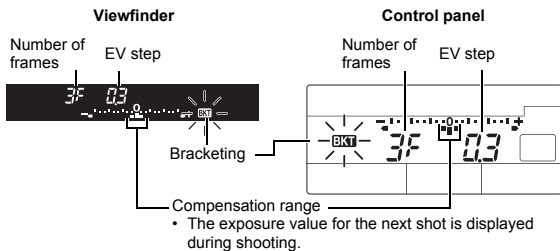

### Start shooting.

- In single-frame shooting, the exposure changes every time the shutter button is pressed.
- In sequential shooting, hold down the shutter button until the selected number of frames are taken.
- Releasing the shutter button stops auto bracketing shooting. When it stops, **BKT** blinks in the viewfinder and on the control panel and **BKT** is displayed in green on the super control panel.



## How AE bracketing compensates exposure in each exposure mode

Depending on the selected exposure mode, exposure is compensated in the following way:

- P** mode : Aperture value and shutter speed
- A** mode : Shutter speed
- S** mode : Aperture value
- M** mode : Shutter speed

### TIPS

**To apply AE bracketing to the exposure value you have compensated:**

→ Compensate the exposure value, then use the AE bracketing feature. AE bracketing is applied to the exposure value you have compensated.

## ISO sensitivity setting

**ISO**

The higher the ISO value, the greater the camera's light sensitivity and the better its ability to shoot in low light conditions. However, higher values may give pictures a grainy appearance.

### Direct button

**ISO +** 

### Super control panel

 **[ISO]**

### Menu

**MENU**  $\blacktriangleright$    $\blacktriangleright$  **[ISO]**

**[AUTO]** : The sensitivity is set automatically according to the shooting conditions. For **[ISO-AUTO SET]**, you can set the default (value normally used when the optimal exposure can be obtained) and upper limit (upper limit of ISO that automatically changes).  "ISO-AUTO SET" (P. 96)

**[100 - 3200]**: Fixed ISO sensitivity. **[ISO STEP]** can be changed to **[1/3EV]** or **[1EV]**.  "ISO STEP" (P. 96)

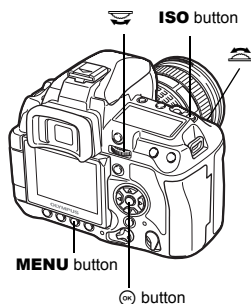

## Setting display

### Viewfinder



When set to **[AUTO]**, the default value is displayed.

### Control panel

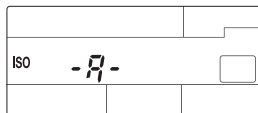

AUTO : **ISO-A**  
100 : 100  
⋮  
3200 : 3200

-A-  
100  
⋮  
3200

- 125 and 1250 are displayed in the viewfinder as 120 and 1200, respectively.

### TIPS

**To automatically set the optimal ISO in M mode:**

→ Normally, the AUTO setting is effective in **P/A/S** mode, but you can set it for use in other shooting modes.  "ISO-AUTO" (P. 96)

## Display after setting

Viewfinder



When set to AUTO, ISO-A and the ISO value determined by the camera are displayed. For all other settings, ISO and the set value are displayed. When set to 2000 or a higher value, ISO blinks.

Control panel

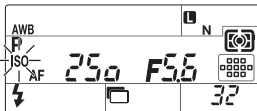

When set to a setting other than AUTO, ISO is displayed. When set to 2000 or a higher value, ISO blinks.

## 3

## ISO bracketing

Exposure

The camera automatically takes pictures at a different ISO sensitivity with the shutter speed and aperture value fixed. 3 images with different exposures are recorded in the order of the set ISO sensitivity (optimum exposure when set to **[AUTO]**), exposure in the – direction, and exposure in the + direction.

**Compensation value: 0.3, 0.7 or 1.0**

- The compensation value is set in 1/3 EV increments regardless of the ISO step setting.

**Number of frames: 3**

Menu

**MENU** > **[C2]** > **[ISO BKT]**

### Notes

- Bracketing is performed regardless of the upper limit set with **[ISO-AUTO SET]**.

## AF mode selection

AF

The three focus modes S-AF, C-AF, and MF are available with this camera. You can take pictures by combining S-AF or C-AF mode with MF mode.

## Direct button

AF + 

## Super control panel

  : [AF MODE]

## Menu

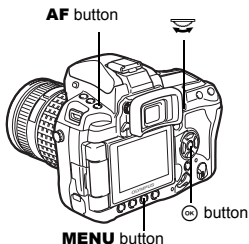
MENU  $\blacktriangleright$  [C2]  $\blacktriangleright$  [AF MODE]

## Setting display

## Viewfinder



## Control panel

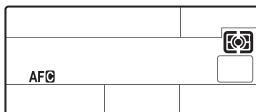

S-AF : S-AF  
 C-AF : C-AF  
 MF : -F  
 S-AF+MF : S-AF -F  
 C-AF+MF : C-AF -F

AF  
 AFG  
 MF  
 MFAF  
 MFAFG

## S-AF (single AF)

Focusing is performed once when the shutter button is pressed halfway.

If focusing fails, release your finger from the shutter button and press it halfway again. This mode is suitable for taking pictures of still subjects or subjects with limited movement.

## Press the shutter button halfway.

- When the focus is locked, the AF confirmation mark lights up.
- A beep sound is output when the subject is in focus.

## Viewfinder

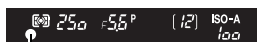

AF confirmation mark

## TIPS

## When it is difficult to focus in the AF mode in low-light conditions:

→ The built-in flash can function as an AF illuminator. This helps with focusing in low-light conditions in the AF mode.  "AF ILLUMINAT." (P. 90)

## When you want to quickly switch from AF mode to MF:

→ By registering [MF] to the Fn button, you can press the Fn button to switch to MF mode.  "Fn" FUNCTION" (P. 92)

**When you want to be able to shoot even if the subject is not in focus:**

→ See "RLS PRIORITY S/RLS PRIORITY C" (P. 94).

**To not light up the AF target in the viewfinder when the subject is in focus:**

→ The AF target in the viewfinder lights red when the subject is in focus. You can set the AF target so as not to turn on. "AF AREA POINTER" (P. 90)

**C-AF (continuous AF)**

The camera repeats focusing while the shutter button remains pressed halfway. When the subject is in motion, the camera focuses on the subject in anticipation of its movement (Predictive AF). Even if the subject moves or you change the composition of the picture, the camera continues trying to focus.

**Press the shutter button halfway and keep it in this position.**

- When the subject is in focus and locked, the AF confirmation mark lights up.
- The AF target does not light up, even when the subject is in focus.
- The camera repeats focusing. Even if the subject moves or even if you change the composition of the picture, focusing is tried continuously.
- A beep sound is output when the subject is in focus. The beep sound is not output after the third continuous AF operation, even when the subject is in focus.

**TIPS****The camera focuses on something passing in front of the subject:**

→ You can set the camera so as not to change the focus even if the distance to the subject changes. "C-AF LOCK" (P. 90)

**MF (manual focus)**

This function allows you to manually focus on any subject while looking through the viewfinder.

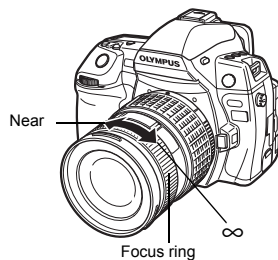
**Adjust the focus using the focus ring.****TIPS****To change the rotational direction of the focus ring:**

→ You can select the rotational direction of the focus ring to suit your preference for how the lens adjusts to the focusing point. "FOCUS RING" (P. 90)

**For information on whether the subject is in focus (Focus aid):**

→ When you focus the lens on a subject manually (by turning the focus ring), the AF confirmation mark lights. When [AF AREA] is set with [AF AREA], AF confirmation lights up if the subject is in focus at the center AF target.

## Simultaneous use of S-AF mode and MF mode (S-AF+MF)

This function allows you to fine-adjust the focus manually by turning the focus ring after AF is performed in the S-AF mode. When the shutter button is not pressed, MF operation is available.

- You can fine-adjust the focus with the focus ring if you have pressed the shutter button halfway and AF is confirmed. You can also fine-adjust the focus with the focus ring when the shutter button is not pressed halfway.

### ! Notes

- If the shutter button is pressed again after fine-adjusting the focus with the focus ring, the AF is activated and your adjustments are canceled.

## Simultaneous use of C-AF mode and MF mode (C-AF+MF)

Focus with the focus ring and press the shutter button halfway to activate C-AF mode.

- While the shutter button is kept pressed, MF cannot be used.
- When the shutter button is not pressed, focusing with MF is possible.

### TIPS

#### Another way to adjust focus manually in C-AF mode:

→ You can set the **AEL/AFL** button to operate C-AF.  "AEL/AFL" (P. 92)

### ! Notes

- If the shutter button is pressed again after fine-adjusting the focus with the focus ring, the AF is activated and your adjustments are canceled.

## AF target selection



This camera has 11 AF targets for focusing on the subject with auto focus. Select the optimal AF target mode according to your subject and the composition.

There are two AF target modes: All target AF mode, which uses AF at all AF targets, and Single target AF mode, which uses AF centering around one selected AF target.

### [⋮] All target AF mode

The camera automatically focuses on the subject in front of the camera from among the 11 AF targets. This is useful for shooting moving subjects or relying on the camera for focusing.

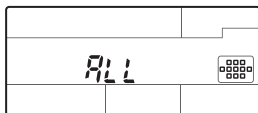
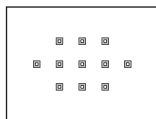

### [ · ] Single target AF mode ([ · ]s Small-single target AF mode)

The camera focuses using one selected AF target. This is useful for accurately focusing on the subject after composing the shot. With [ · ], you can focus using a range that is somewhat larger than one AF target, but you can only set the range within the AF target. When

**[SMALL]** is selected for **[AF SENSITIVITY]**, the setting display changes to [ · ]s.  "AF SENSITIVITY" (P. 90)

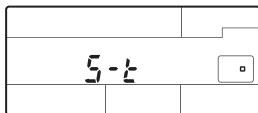

## [::]Dynamic-single target AF mode

If the camera cannot focus on the subject using the selected AF target, the camera focuses using the adjacent AF target.

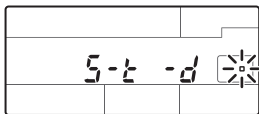
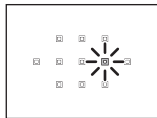
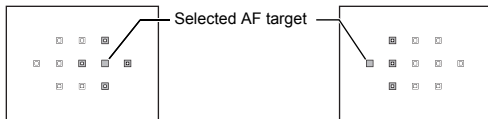

### Direct button

[::] +

- When the button is released, the currently selected AF target lights. When [·] or [::] is set, you can select the AF target to be used at that point. For operation, refer to Step 2 in "Selecting the AF target position" (P. 54) in the next section.

### Super control panel

> : [AF AREA] > [::]  
+

- When [·] or [::] is set, you can turn the dial to select the AF target.

### Menu

MENU > [AF] > [AF AREA]

- When [·] or [::] is set, you can select the AF target with .

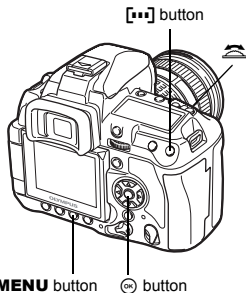

## Selecting the AF target position

Select the AF target to use with Single target AF mode.

- 1 Press the [::] button and release your finger to enable selection of the AF target.
- 2 Use the main dial/sub dial or arrow pad to select the AF target.

- Use the main dial to perform the same operation as and use the sub dial to perform the same operation as .
- You can change the operation of the dials and arrow pad for selecting the AF target. " [::] SET UP" (P. 91)
- Press the button to return the position of the AF target to the center.

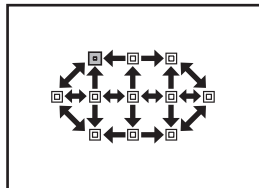

## Registering an AF target mode

You can register a frequently used AF target mode and the position of that AF target. You can then quickly load that registered setting (“home position”) and use it when shooting.

### Registering

**1** In the screen of Step 2 of “Selecting the AF target position” (P. 54), press the **Fn** button and **[HOME]** button at the same time.

- The home position is registered at the time the buttons are pressed.
- The home position cannot be registered when operated from a menu.



Indicates that the AF target is being registered.

### Shooting

To use this function, you must assign the **[HOME]** function to the **Fn** button in advance. (P. 92)

**1** Press the **Fn** button.

- The registered home position is selected. Press this button again to switch to the original AF target mode.

### Notes

- The AF sensitivity is not recorded when registering the home position.

## Focus lock — If correct focus cannot be obtained

The camera's auto focus may not be able to focus on the subject in situations such as when the subject is not in the center of the frame. If this happens, the easiest solution is to use focus lock. Use this when composing the subject outside of the 11 AF targets or when the subject is difficult to focus on.

**1** Adjust the AF target with the subject to be focused and press the shutter button halfway until the AF confirmation mark lights up.

- The focus is locked. The AF confirmation mark and the AF target in focus light up in the viewfinder.
- If the AF confirmation mark blinks, press the shutter button halfway again.
- While the shutter button is being pressed, the super control panel disappears.

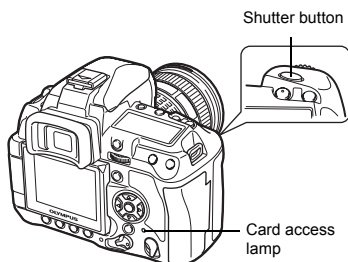

## 2 While pressing the shutter button halfway, move to the desired composition and press the button all the way.

- The card access lamp blinks while the picture is being stored on the card.

e.g.) The camera focuses using the center AF target.

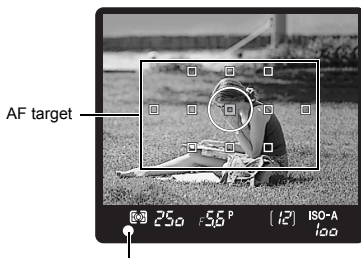

AF confirmation mark







### If the subject has lower contrast than its surroundings

If the contrast of the subject is weak, such as when the lighting is insufficient or the subject cannot be seen clearly because of fog, the focus may not be achieved. Focus (focus lock) on a high-contrast object the same distance away as the intended subject, recompose your shot and then take the picture.

## Sequential shooting



- Single-frame shooting  Shoots 1 frame at a time when the shutter button is pressed (normal shooting mode).
- Sequential shooting H  Shoots at 5 frames/sec. for as long as the shutter button is pressed (during JPEG).
- Sequential shooting L  Shoots at the set speed ( "L fps" (P. 94)) for as long as the shutter button is pressed.

- Press the shutter button fully and keep it pressed. The camera will take pictures in sequence until you release the button.
- Focus, exposure, and white balance are locked at the first frame (during S-AF, MF).

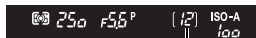

Number of sequential shots that can be taken

### ! Notes

- During sequential shooting, if the battery check blinks due to low battery, the camera stops shooting and starts saving the pictures you have taken on the card. The camera may not save all of the pictures depending on how much battery power remains.



## Setting method

### Direct button



### Super control panel

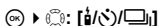

⚡/⌚/📷 button

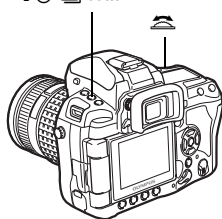

## Setting display

Viewfinder



Control panel



Single-frame shooting

Sequential shooting H : b-d H

Sequential shooting L : b-d L

12-second self-timer : SEL F 12

2-second self-timer : SEL F 2

Remote control : 1-d 0

2-second remote control : 1-d 2



### • Anti-shock display:

A blinking display in the viewfinder or on the control panel and the ⚡ symbol on the super control panel indicates that anti-shock is activated.

## Self-timer shooting



This function lets you take pictures using the self-timer. You can set the camera to release the shutter after either 12 or 2 seconds. Fix the camera securely on a tripod for self-timer shooting.

For the setting method, see "Sequential shooting" (P. 56).

### Press the shutter button all the way.

- A picture is taken.
- When ⌚12s is selected:  
First, the self-timer lamp lights up for approximately 10 seconds, then it blinks for approximately 2 seconds and the picture is taken.
- When ⌚2s is selected :  
The self-timer lamp blinks for approximately 2 seconds, and then the picture is taken.
- To cancel the activated self-timer, press the ⚡/⌚/📷 button.

Self-timer lamp

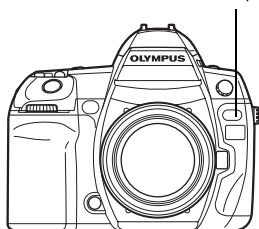

## Notes

- Do not press the shutter button while standing in front of the camera; this could result in the subject being out of focus since focusing is performed when the shutter button is pressed halfway.

### Eyepiece shutter

When shooting without looking through the viewfinder, close the eyepiece shutter to block the viewfinder so that light does not enter the viewfinder and change the exposure. Lift the eyepiece shutter lever.

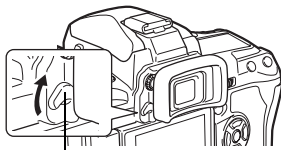

Eyepiece shutter lever

## Remote control shooting



4

Focusing and shooting functions

By using the optional remote control (RM-1), you can take a picture with yourself in it or a night scene without touching the camera.

The camera can be set to release the shutter either right away or 2 seconds after the shutter button on the remote control is pressed. Bulb shooting is also possible when using the optional remote control.

For the setting method, see "Sequential shooting" (P. 56).

**Mount the camera securely on a tripod, point the remote control at the remote control receiver on the camera and press the shutter button on the remote control.**

- When **0s** is selected :  
The focus and exposure are locked, the remote control lamp blinks and the picture is taken.
- When **2s** is selected :  
The focus and exposure are locked, the remote control lamp blinks, and after approximately 2 seconds the picture is taken.

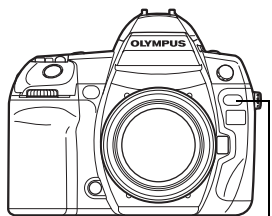

Remote control lamp  
Remote control receiver

### Transmitted signal effective area

Point the remote control at the remote control receiver of the camera within the effective area as shown below.

When powerful lighting such as direct sunlight is shining on the remote control receiver, or when fluorescent light or devices emitting electrical or radio waves are nearby, it could narrow the effective area.

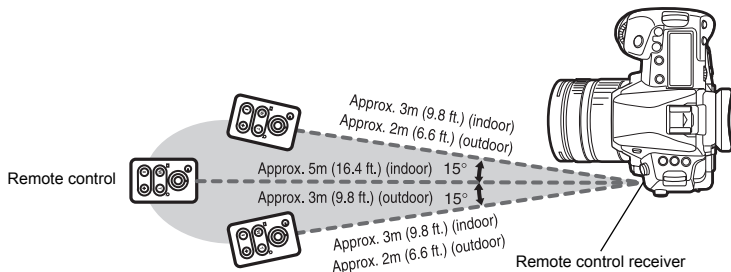

## TIPS

### The remote control lamp does not blink after the shutter button on the remote control is pressed:

- The transmitted signal may not be effective if the remote control receiver is exposed to powerful lighting. Move the remote control closer to the camera and press the shutter button on the remote control again.
- The transmitted signal may not be effective if the remote control is too far from the camera. Move the remote control closer to the camera and press the shutter button on the remote control again.
- There is signal interference. Change the channel as described in the remote control's manual.

### To cancel the remote control shooting mode:

- The remote control shooting mode will not be canceled after shooting. Press the button to set to [□] (single-frame shooting), etc.

### To use the shutter button on the camera in the remote control shooting mode:

- The shutter button on the camera still works even in the remote control shooting mode.

## Notes

- The shutter will not be released if the subject is not in focus.
- Under bright light conditions, the remote control lamp may be difficult to see, making it hard to determine whether or not the picture has been taken.
- Zoom is not available on the remote control.

## Bulb shooting with the remote control

Set the shooting mode to [B]. "Bulb shooting" (P. 44)

Press the W button on the remote control to open the shutter. When the time set in "BULB TIMER" ( P. 96) elapses, the shutter closes automatically.

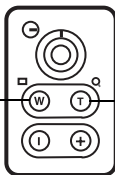

Press the T button to close the shutter.

## Anti-shock

You can select the interval from the time the mirror is raised until the shutter is released. This diminishes camera shake caused by vibrations when the mirror moves. This feature can be useful in astrophotography and microscope photography or other photographic situations where a very slow shutter speed is used, and camera vibration needs to be kept to a minimum.

- 1 MENU  $\blacktriangleright$  [Q2]  $\blacktriangleright$  [ANTI-SHOCK[♦]]
- 2 Select from 1 to 30 seconds for the time after the mirror is raised until the shutter is released and press the button.
- 3 Anti-shock is added to the shooting functions individually (single-frame shooting, sequential shooting, self-timer shooting, and remote control shooting). For the setting method, see "Sequential shooting" ( P. 56).

You can reduce the amount of camera shake that easily occurs when shooting in low light situations or shooting with high magnification.

**OFF** Image stabilizer is off.

**I.S. 1** Image stabilizer is on.

**I.S. 2** This is used when panning in the horizontal direction to achieve a blurred background. The horizontal image stabilizer is turned off, and only the vertical image stabilizer is activated.

**1** Press and release the IS button, and then use the dial to make the setting.

### Setting display



Viewfinder

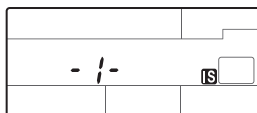

Control panel

: OFF  
 : I.S. 1  
 : I.S. 2

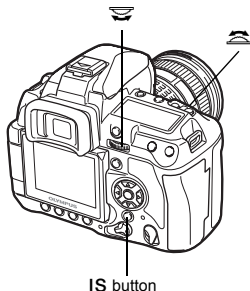

IS button

### Checking the image stabilizer effect with live view

You can hold down the IS button during live view to see the effect of the image stabilizer on the monitor. While in that position, you can press the shutter button fully to take a picture.

- When **[IMAGE STABILIZER]** is set to **[OFF]**, pressing and holding the IS button activates the image stabilizer (**I.S. 1**).
- Either releasing the IS button or holding down the IS button for several seconds turns off the image stabilizer.

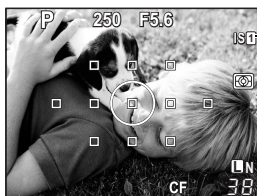

Green: Image stabilizer active

Red : Image stabilizer failure

### Notes

- The image stabilizer cannot correct excessive camera shake or camera shake that occurs when the shutter speed is set to the slowest speed. In these cases, it is recommended that you use a tripod.
- When using a tripod, set **[IMAGE STABILIZER]** to **[OFF]**.
- When using a lens with an image stabilization function, turn off the image stabilization function of either the lens or the camera.
- Turning off the camera initializes the image stabilizer function. The camera will vibrate for this operation, but this is not a malfunction.
- A red **IS T** displayed on the monitor indicates the failure of the image stabilizer function. If you take a picture as is, the composition may be off. Consult your Olympus Authorized Service Center.

## Selecting the record mode

You can select a record mode in which to take pictures. Choose the record mode that is best for your purpose (printing, editing on a PC, website editing, etc.).

### Recording formats

#### JPEG

For JPEG images, select a combination of image size (**L**, **M**, **S**) and compression rate (SF, F, N, B). An image consists of pixels (dots). When you enlarge an image with a low pixel count, it will be displayed as a mosaic. If an image has a high pixel count, the file size (amount of data) will be larger and the number of storable still pictures will be lower. The higher the compression, the smaller the file size. However, the image will have less clarity when played back.

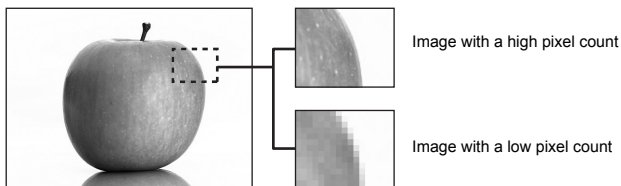

Image becomes clearer ←

Application	Number of pixels	Pixel count	Compression rate			
			SF (Super Fine) 1/2.7	F (Fine) 1/4	N (Normal) 1/8	B (Basic) 1/12
Select for the print size	<b>L</b> (Large)	3648 × 2736	<b>L</b> SF	<b>L</b> F	<b>L</b> N	<b>L</b> B
		3200 × 2400	<b>M</b> SF	<b>M</b> F	<b>M</b> N	<b>M</b> B
	2560 × 1920					
	1600 × 1200					
For small-sized prints and use on a web site	<b>S</b> (Small)	1280 × 960	<b>S</b> SF	<b>S</b> F	<b>S</b> N	<b>S</b> B
		1024 × 768				
		640 × 480				

#### RAW

This is unprocessed data that has not undergone changes in white balance, sharpness, contrast or color. To display as an image on the computer, use OLYMPUS Master. RAW data cannot be displayed on a different camera or by using common software, and it cannot be selected for print reservation.

It is possible to edit images taken with the record mode set to RAW data using this camera.

"Editing still images" (P. 84)

## Selecting the record mode

### JPEG

For JPEG, you can register 4 combinations of images sizes (L, M, S) and compression rates (SF, F, N, B) from the 12 total combinations available. "SET" (P. 97)  
You can select M or S for the image size and select the pixel size.  
 "PIXEL COUNT" (P. 98)

### RAW+JPEG

Records both a JPEG and RAW image at the same time each time you take a picture.

### RAW

Records the image in RAW data format.

e.g.) The following 9 record modes are available when L/F/LN/MN/SN are registered

RAW : RAW

JPEG : L/F/LN/MN/SN

RAW+JPEG : RAW+L/F/RAW+LN/RAW+MN/RAW+SN

### Super control panel



## 5

### Menu

MENU > [Fn] > [Fn]

### TIPS

#### To quickly set the record mode:

→ By setting [RAW] to the Fn button, you can turn the dial while pressing the Fn button to change the record mode.

Each time you press the Fn button, you can easily switch between JPEG data only and JPEG and RAW data.

"FUNCTION" (P. 92)

#### To find out the file size/number of storable still pictures for each record mode:

→ "Record mode and file size/number of storable still pictures" ( P. 133)

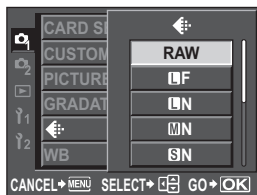
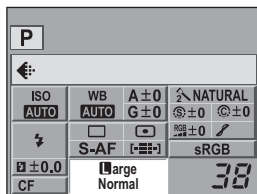

## Selecting the white balance

Color reproduction differs depending on the light conditions. For instance, when daylight or tungsten lighting is reflected on white paper, the shade of white produced will be slightly different for each. With a digital camera, white color can be adjusted to reproduce more natural white with a digital processor. This is called white balance. There are 4 options for setting the WB with this camera.

### Auto white balance [AUTO]

This function enables the camera to automatically detect white in images and adjust the color balance accordingly. Use this mode for general use.

### Preset white balance [WB]

8 different color temperatures are programmed on this camera covering a variety of indoor and outdoor lighting including fluorescent lights, light bulbs, and flashes. For example, use preset WB when you want to reproduce more red in the picture of a sunset, or capture a warmer artistic effect under artificial lighting.

### Custom white balance [CWB]

You can set the color temperature from 2000K to 14000K. For details on color temperature, refer to "White balance color temperature" (P. 132).

☞ "Setting the auto/preset/custom white balance" (P. 63)

### One-touch white balance [C1][C2][C3][C4]

You can set the optimum white balance for the shooting conditions by pointing the camera at a white object like a sheet of white paper. The white balance achieved with this setting is saved as one of the preset WB settings. 4 one-touch white balance settings are registered.

☞ "Setting the one-touch white balance" (P. 65)

WB mode	Light conditions
AUTO	Used for most light conditions (when there is a white portion framed in the viewfinder). Use this mode for general use.
☀ 5300K	For shooting outdoors on a clear day, or to capture the reds in a sunset or the colors in a fireworks display
🏠 7500K	For shooting outdoors in the shadows on a clear day
☁ 6000K	For shooting outdoors on a cloudy day
💡 3000K	For shooting under a tungsten light
💡 4000K	For shooting under white fluorescent lighting
💡 4500K	For shooting under a neutral white fluorescent lamp
💡 6600K	For shooting under a daylight fluorescent lamp
WB 5500K	For flash shooting
📷 1-4	Color temperature set by one-touch WB. ☞ "Setting the one-touch white balance" (P. 65)
CWB	Color temperature set in custom white balance menu. This can be set from 2000K to 14000K. When the value has not been set, it is set to 5400K.

### Setting the auto/preset/custom white balance

WB

You can adjust the white balance by selecting the appropriate color temperature for the light conditions.

#### Direct button

WB + 📷 / 📷

#### Super control panel

📷 ▶ 📷: [WB]

- Custom white balance is set by selecting [CWB] and turning the dial while pressing down the ☑ button.

#### Menu

MENU ▶ [C] ▶ [WB]

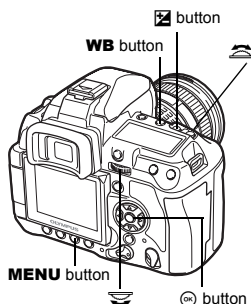

## Setting display

### Viewfinder



- During custom white balance, the color temperature is displayed.

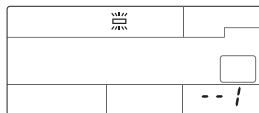

### Control panel

-A- : AWB

-dL- : ☀

-SH- : ☀

-CL- : ☁

-LA- : ☀

--1 : ☀ --1

--2 : ☀ --2

--3 : ☀ --3

-FL- : ⚡

0-1 : [WB] 0-1

0-2 : [WB] 0-2

0-3 : [WB] 0-3

0-4 : [WB] 0-4

5400 : [K] 5400

### TIPS

#### When subjects that are not white appear white:

→ In the auto WB setting, if there is no near-white color in the image framed in the screen, the white balance will not be correctly determined. In such a case, try preset WB or one-touch WB settings.

#### White balance sensor

This camera has a white balance sensor for determining the light source in the shooting environment. The white balance sensor measures and calculates the infrared and visible light, and determines whether the light source is sunlight, fluorescent lighting, floodlighting, a blue flat lamp, or other lighting. When shooting, be careful not to cover or shade the sensor.

White balance sensor

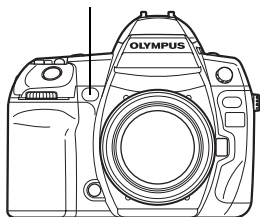

#### WB compensation

This function lets you make fine changes to the auto WB and preset WB settings.

##### Direct button

**WB +** [A] : adjust in A direction/  
[G] : adjust in G direction

- Use the sub dial to set in the A direction or the main dial to set in the G direction.

##### Super control panel

[WB] [WB]

##### Menu

**MENU** [WB] [WB]

- Select the white balance to adjust and press [OK].

5

Record mode, white balance, and picture mode



## Adjusting the white balance in the A direction (Amber-Blue)

Depending on the original WB conditions, the image will become more amber when adjusted toward +, and bluer when adjusted toward –.

## Adjusting the white balance in the G direction (Green-Magenta)

Depending on the original WB conditions, the image will become greener when adjusted toward +, and magenta when adjusted toward –.

- The white balance can be adjusted in 7 increments in each direction.



Direct buttons setting screen

## Setting display

e.g.) When the A direction and G direction are each adjusted toward –

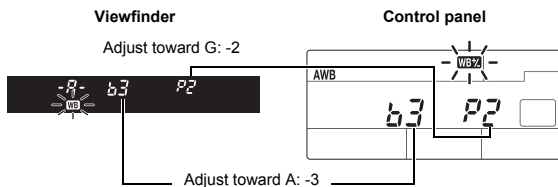

### TIPS

#### Checking the white balance you have adjusted:

→ After setting the compensation value, point the camera at the subject to take test shots. When the **AEL/AFL** button is pressed, sample images that have been taken with the current WB settings are displayed.

#### Adjusting all WB mode settings at once:

→ See "ALL **WB**" (P. 97).

## Setting the one-touch white balance

This function is useful when you need a more precise white balance than preset WB can provide. Point the camera at a sheet of white paper under the light source you want to use to determine the white balance. The optimum white balance for the current shooting conditions can be saved for up to 4 settings in the camera. This is useful when shooting a subject under natural light, as well as under various light sources with different color temperatures.

Set **[Fn] FUNCTION** to **[Fn]** beforehand. (P. 92)

### 1 Point the camera at a sheet of white paper.

- Position the paper so that it fills the viewfinder. Make sure there are no shadows.

### 2 While holding down the **Fn** button, press the shutter button.

- The one-touch white balance screen appears.

### 3 Select the one-touch white balance number to be registered, and press the **⊖** button.

- The white balance is registered.
- The registered white balance will be stored in the camera as a preset WB setting. Turning the power off does not erase the data.

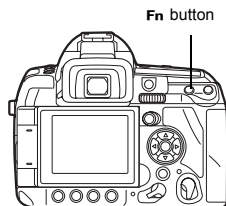

## TIPS

After pressing the shutter button, [WB NG RETRY] is displayed:

- When there is not enough white in the image, or when the image is too bright, too dark or the colors look unnatural, you cannot register the white balance. Change the aperture and shutter speed settings, then repeat the procedure from Step 1.

## WB bracketing

Three images with different white balances (adjusted in specified color directions) are automatically created from one shot. One image has the specified white balance, while the others are the same image adjusted in different color directions.

### Direct button

**WB + MODE**  $\blacktriangleright$  : EV step in A-B direction/  
 : EV step in G-M direction

- Use the sub dial to set in the A-B direction or the main dial to set in the G-M direction.

### Menu

**MENU**  $\blacktriangleright$   $\blacktriangleright$  [WB BKT]

### Setting display

5

Record mode, white balance, and picture mode

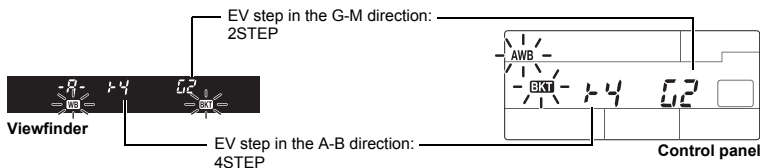

- Select from [OFF], [3F 2STEP], [3F 4STEP], or [3F 6STEP] for the EV step for both the A-B (amber-blue) direction and the G-M (green-magenta) direction.
- When the shutter button is pressed down all the way, 3 images adjusted in specified color directions are automatically created.



Direct buttons setting screen

## TIPS

To apply WB bracketing to the white balance you have adjusted:

- Adjust white balance manually, then use the WB bracketing feature. WB bracketing is applied to the white balance you have adjusted.

## Notes

- During WB bracketing, the camera cannot shoot in sequence if there is not enough memory in the camera and card for storing more than the selected number of frames.

## Picture mode

You can select image tone to create unique image effects. You can also fine-adjust image parameters such as contrast and sharpness for each mode. The adjusted parameters are recorded in each picture effect mode.

- [**VIVID**] : Produces vivid colors.
- [**NATURAL**] : Produces natural colors.
- [**MUTED**] : Produces flat tones.
- [**PORTRAIT**] : Produces beautiful skin tones.
- [**MONOTONE**] : Produces black and white tone.
- [**CUSTOM**] : Select one picture mode, set the parameters, and register the setting. You can also register the gradation to [**CUSTOM**]. This setting is set separately from [**GRADATION**] in the menu. "Gradation" (P. 8)

### Super control panel

: [PICTURE MODE]

### Menu

MENU > [P] >  
[PICTURE MODE]

The adjustable parameters are classified according to the picture modes.

The individual parameters are as follows.

- [**CONTRAST**] : Distinction between light and dark
- [**SHARPNESS**] : Sharpness of the image
- [**SATURATION**] : Vividness of the color
- [**B&W FILTER**] : Creates a black and white image. The filter color is brightened and the complementary color is darkened.
  - [**N: NEUTRAL**] : Creates a normal black and white image.
  - [**Ye: YELLOW**] : Reproduces clearly defined white cloud with natural blue sky.
  - [**Or: ORANGE**] : Slightly emphasizes colors in blue skies and sunsets.
  - [**R: RED**] : Strongly emphasizes colors in blue skies and brightness of crimson foliage.
  - [**G: GREEN**] : Strongly emphasizes colors in red lips and green leaves.
- [**PICT. TONE**] : Colors the black and white image.
  - [**N: NEUTRAL**] : Creates a normal black and white image.
  - [**S: SEPIA**] : Sepia
  - [**B: BLUE**] : Bluish
  - [**P: PURPLE**] : Purplish
  - [**G: GREEN**] : Greenish

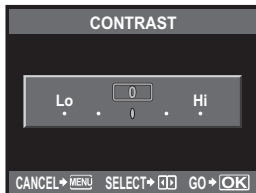
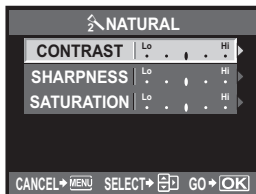
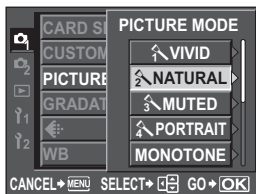

5

Record mode, white balance, and picture mode

## Gradation

In addition to the **[NORMAL]** gradation setting, you can select from 3 other gradation settings.

**[HIGH KEY]** : Gradation for a bright subject.

**[LOW KEY]** : Gradation for a dark subject.

**[AUTO]** : Divides the image into detailed regions and adjusts the brightness separately for each region. This is effective for images with areas of large contrast in which the whites appear too bright or the blacks appear too dark.

**[NORMAL]** : Use **[NORMAL]** mode for general uses.



**HIGH KEY**

Suitable for a subject that is mostly highlighted.

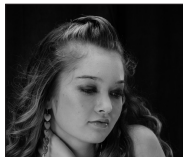

**LOW KEY**



Suitable for a subject that is mostly shadowed.

### 5

**Super control panel**

  : **[GRADATION]**

**Menu**

**MENU**  **[Q]**  **[GRADATION]**

#### **Notes**

- Contrast adjustment does not work when set to **[HIGH KEY]**, **[LOW KEY]**, or **[AUTO]**.

## Noise reduction

This function reduces the noise that is generated during long exposures. When shooting night scenes, shutter speeds are slower and noise tends to appear in images. When the shutter speed is slow, noise reduction is activated and the camera automatically reduces noise to produce clearer images. However, shooting time is approximately twice as long as usual.



OFF



ON

### Menu

### MENU > [C] > [NOISE REDUCT.]

- The noise-reduction process is activated after shooting.
- The card access lamp blinks during the noise-reduction process. You cannot take more pictures until the card access lamp turns off.
- **[busy]** is displayed on the viewfinder while noise reduction is operating.

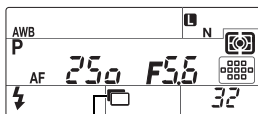

Noise reduction [ON]

### ! Notes

- During sequential shooting, **[NOISE REDUCT.]** is **[OFF]** automatically.
- This function may not work effectively with some shooting conditions or subjects.

## Noise filter

You can select the noise processing level. Use **[STANDARD]** for general use. **[HIGH]** is recommended during high sensitivity shooting.

### Menu

### MENU > [C] > [NOISE FILTER]

## Flash mode setting



The camera sets the flash mode according to various factors such as firing pattern and flash timing. Available flash modes depend on the exposure mode. The flash modes are available to optional external flashes.

### Auto flash AUTO

The flash fires automatically in low light or backlight conditions. To shoot a subject with backlighting, position the AF target over the subject.

### Flash synchronization speed/Slow limit

Shutter speed can be changed when the built-in flash fires. "X-SYNC." (P. 96), "SLOW LIMIT" (P. 96)

### Red-eye reduction flash

In the red-eye reduction flash mode, a series of pre-flashes are emitted just before the regular flash fires. This helps accustom the subject's eyes to the bright light and minimizes the red-eye phenomenon. In **S/M/B** mode, the flash always fires.



The subject's eyes appear red

### Notes

- After the pre-flashes, it takes about 1 second before the shutter is released. Hold the camera firmly to avoid camera shake.
- Effectiveness may be limited if the subject is not looking directly at pre-flashes, or if the shooting range is too far. Individual physical characteristics may also limit effectiveness.

### Slow synchronization (1st curtain)

The slow synchronization flash is designed for slow shutter speeds. Normally, when shooting with a flash, shutter speeds cannot go below a certain level to prevent camera shake. But when shooting a subject against a night scene, fast shutter speeds can make the background too dark. Slow synchronization allows you to capture both the background and the subject. Since the shutter speed is slow, be sure to stabilize the camera by using a tripod so as not to cause the picture to be blurred.



### 1st curtain

Usually, the flash fires right after the shutter fully opens. This is called 1st curtain. This method is usually used during flash shooting.

## Slow synchronization (2nd curtain) ⚡ SLOW2/2nd CURTAIN

2nd curtain flash fires just before the shutter closes. Changing the flash timing can create interesting effects in your picture, such as expressing the movement of a car by showing the tail-lights streaming backwards. The slower the shutter speed, the better the effects turn out. In **S/M/B** mode, the flash always fires.

When the shutter speed is set to 2 sec.

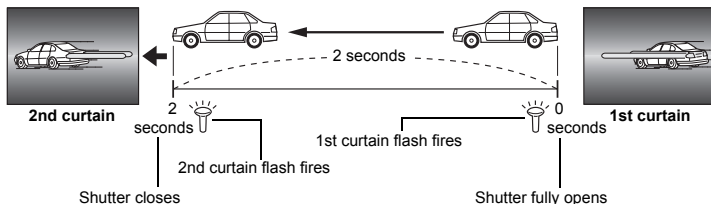

## Slow synchronization (1st curtain)/Red-eye reduction flash 👁 SLOW

While using slow synchronization with flash shooting, you can also use this function to achieve red-eye reduction. When shooting a subject against a night scene, this function allows you to reduce the red-eye phenomenon. As the time from emitting pre-flashes to shooting is long in 2nd curtain synchronization, it is difficult to achieve red-eye reduction. Hence, only 1st curtain synchronization setting is available.

## Fill-in flash ⚡

The flash fires regardless of the light conditions. This mode is useful for eliminating shadows on the subject's face (such as shadows from tree leaves), in a backlight situation, or for correcting the color shift produced by artificial lighting (especially fluorescent light).



### ! Notes

- When the flash fires, the shutter speed is set to 1/250 sec. or less. When shooting a subject against a bright background with the fill-in flash, the background may be overexposed. In this case, use the optional FL-50R external flash or a similar flash and shoot in the Super FP flash mode. 📖 "Super FP flash" (P. 76)

## Flash off 🚫

The flash does not fire.

Even in this mode, the flash can be used as an AF illuminator when it is raised.

📖 "AF ILLUMINAT." (P. 90)

## Manual flash

This allows the built-in flash to output a fixed amount of light. To shoot with manual flash, set the f-number on the lens based on the distance to the subject.

Ratio of amount of light	GN: Guide number (Equivalent to ISO 100)
FULL (1/1)	13
1/4	6.5
1/16	3.3
1/64	1.6

Calculate the f-number on the lens using the following formula.

$$\text{Aperture (f-number)} = \frac{\text{GN} \times \text{ISO sensitivity}}{\text{Distance to the subject (m)}}$$

## ISO sensitivity

ISO value	100	200	400	800	1600	3200
ISO sensitivity	1.0	1.4	2.0	2.8	4.0	5.6

## Direct button



⚡ button



## Super control panel

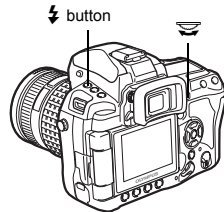

6

Flash shooting

## Setting display

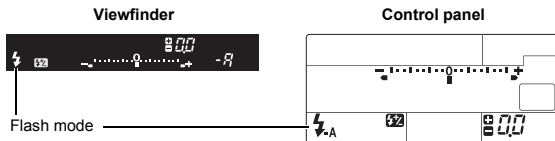

- For details on displaying the settings, refer to “Flash modes that can be set by shooting mode” (P. 131).



## Built-in flash shooting

- 1 Press the **UP** button to raise the built-in flash.

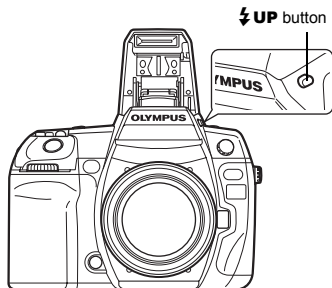

- 2 Press the shutter button halfway.
  - The **Flash stand-by mark** lights when the flash is ready to fire. If the mark is blinking, the flash is charging. Wait until charging is complete.
- 3 Press the shutter button all the way.

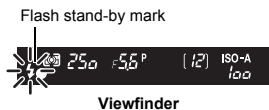

### TIPS

To shoot without having to wait for the flash to finish charging:

→ See "RLS PRIORITY S/RLS PRIORITY C" (P. 94).

### Notes

- Depending on the distance to the subject or the lens being used, the light emitted by the flash may produce a vignette effect. See "Vignetting of the built-in flash when using an interchangeable lens" (P. 130)

## Flash intensity control

The flash intensity can be adjusted from +3 to -3.

In some situations (e.g., when shooting small subjects, distant backgrounds, etc.), you may get better results by adjusting the amount of light emitted by the flash ("flash intensity"). It is useful when you intend to increase the contrast (distinction between light and dark) of images to make the images more vivid.

### Direct button



### Super control panel



### Menu

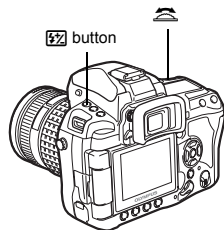

## Setting display

Viewfinder



Control panel

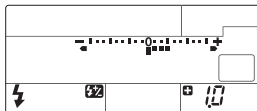

### TIPS

#### To adjust the flash using only the dials:

→ Assign the flash intensity control function to the main dial (or sub dial). "DIAL" (P. 91)

#### Notes

- This does not work during manual flash.
- This does not work when the flash control mode on the electronic flash is set to MANUAL.
- If flash intensity is adjusted on the electronic flash, it will be combined with the camera's flash intensity setting.
- When is set to [ON], the flash intensity value will be added to the exposure compensation value. "DIAL" (P. 96)

## Flash bracketing

The camera shoots multiple frames, changing the amount of light emitted by the flash for each shot. The camera shoots 3 frames at a time with the following amount of light: optimum light, light adjusted in the - direction, and light adjusted in the + direction.

6

### Menu

MENU ▶ ▶ [FL BKT]

- Flash shooting
- The compensation value will change according to the EV step. "EV STEP" (P. 96)
  - In single-frame shooting, the amount of light emitted by the flash changes every time the shutter button is pressed.
  - In sequential shooting, hold down the shutter button until the selected number of frames are taken.
  - Releasing the shutter button stops flash bracketing shooting. When it stops, **BKT** blinks in the viewfinder and on the control panel and **BKT** is displayed in green on the super control panel.

## External flash shooting

In addition to the camera's built-in flash capabilities, you can use any of the external flash units specified for use with this camera. This enables you to take advantage of a wider variety of flash shooting techniques to suit different shooting conditions.

The external flashes communicate with the camera, allowing you to control the camera's flash modes with various available flash control modes, such as TTL-AUTO and Super FP flash. An external flash unit specified for use with this camera can be mounted on the camera by attaching it to the camera's hot shoe. You can also attach the flash to the flash bracket on the camera using the bracket cable (optional).

Refer to the external flash's manual as well.

## Functions available with external flash units

Optional flash	FL-50R	FL-50	FL-36R	FL-36	FL-20	RF-11	TF-22
Flash control mode	TTL-AUTO, AUTO, MANUAL, FP TTL AUTO, FP MANUAL				TTL-AUTO, AUTO, MANUAL	TTL-AUTO, MANUAL	
GN (Guide number) (ISO100)	GN50 (85 mm <sup>*</sup> ) GN28 (24 mm <sup>*</sup> )		GN36 (85 mm <sup>*</sup> ) GN20 (24 mm <sup>*</sup> )		GN20 (35 mm <sup>*</sup> )	GN11	GN22
RC mode	✓	—	✓	—	—	—	—

\* The focal length of the lens that can be used (Calculated based on 35 mm film camera)

### ! Notes

- The FL-40 optional flash cannot be used.

## Using the external electronic flash

Be sure to attach the flash to the camera before turning on the flash's power.

### 1 Remove the hot shoe cover by sliding it in the direction indicated by the arrow in the illustration.

- Keep the shoe cover in a safe place to avoid losing it, and put it back on the camera after flash shooting.

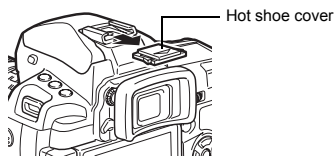

### 2 Attach the electronic flash to the hot shoe on the camera.

- If the lock pin is protruding, turn the shoe lock ring as far as it will go in the direction opposite to LOCK. This will pull the lock pin back inside.

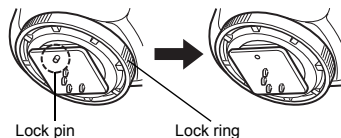

### 3 Turn on the flash.

- When the charge lamp on the flash lights up, charging is complete.
- The flash will be synchronized with the camera at a speed of 1/250 sec. or less.

### 4 Select a flash mode.

### 5 Select the flash control mode.

- TTL-AUTO is recommended for normal use.

### 6 Press the shutter button halfway.

- Shooting information such as ISO sensitivity, aperture value, and shutter speed is communicated between the camera and flash.

### 7 Press the shutter button all the way.

### ! Notes

- The built-in flash cannot be used when an external flash is attached to the hot shoe.

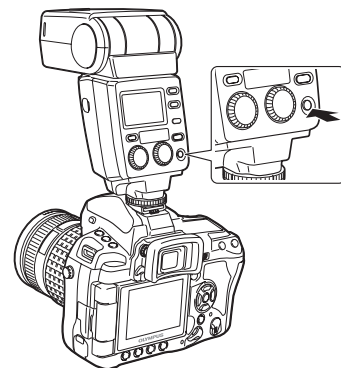

## Super FP flash

Super FP flash is available with the FL-50R or FL-36R. Use the Super FP flash where normal flashes cannot be used with high shutter speed.

Fill-in flash shooting with the aperture open (such as in outdoor portrait shooting) is also possible with Super FP flash. For details, refer to the external flash's manual.

Super FP flash



Viewfinder

## Shooting with the Olympus wireless RC flash system

Wireless flash shooting is possible with the Olympus wireless RC flash system. With this wireless flash system, you can take pictures using multiple wireless flashes and control the flashes in three groups (A, B, and C). The built-in flash is used to communicate between the camera and the external flashes.

For details on using the wireless flash, see the manual of the external flash.

### Wireless flash setup range

Position the wireless flash so that the wireless sensor faces the camera. The setup range guidelines are as shown below. The range changes according to the surrounding environment.

6

Flash shooting

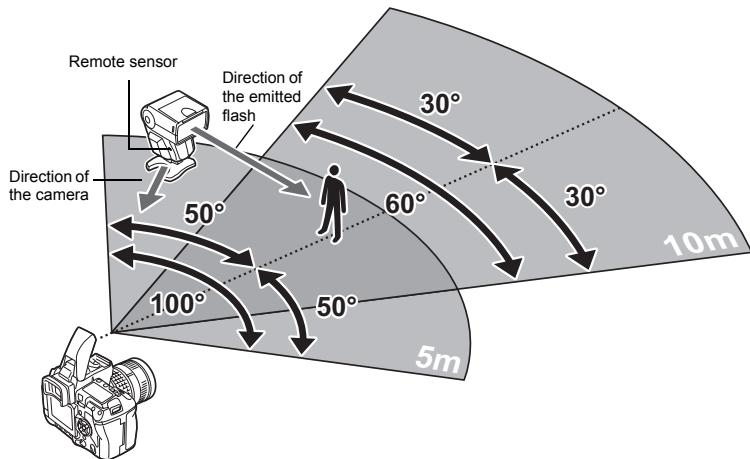

- 1 Position the flash while referring to the “Wireless flash setup range”, and turn on the flash.
- 2 Press the **MODE** button on the flash to set it to RC mode, and set the channel and group of the flash.
- 3 Set RC mode on the camera to [ON].
  - **MENU** ▶ [C] ▶ [⚡ RC MODE] ▶ [ON]
  - The super control panel switches to RC mode.
  - You can press the **INFO** button to switch the super control panel display.

#### 4 Use the super control panel to set the flash mode and other settings for each group.

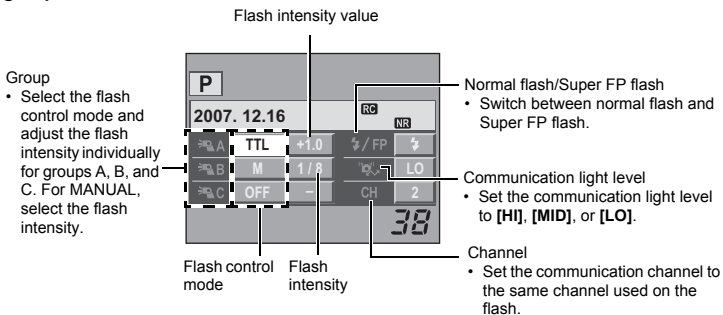

#### 5 Select a flash mode.

- Red-eye reduction flash is not possible in RC mode.

#### 6 Press the **UP** button to raise the built-in flash.

#### 7 After shooting preparations are completed, take some test shots to check the flash operation and images.

#### 8 Begin shooting while checking the charging completed indications of the camera and flash.

#### ! Notes

- Although there is no limit to the number of wireless flashes you can use, it is recommended that each group have no more than three flashes to prevent flash malfunction due to mutual interference.
- In RC mode, the built-in flash is used to control the wireless flash. The built-in flash cannot be used for flash shooting in this mode.
- For 2nd curtain synchronization, set the shutter speed and anti-shock settings to within 4 seconds. Wireless flash shooting may not operate properly when using a slower shutter speed or anti-shock setting.

## Using commercially available flashes

You cannot use the camera to adjust the amount of light emitted from a commercially available flash except for a flash specified for use with this camera. To use a commercially available flash, connect it to the hot shoe or connect the synchronization cord to the external flash connector. Set the camera's shooting mode to **M**. For details on non-specified commercial flashes, see "Non-specified commercial flashes" (P. 78).

**1 Remove the hot shoe cover to connect the flash unit to the camera.**

**2 Set the shooting mode to M, then set the aperture value and shutter speed.**

- Set the shutter speed to 1/250 sec. or slower. If the shutter speed is faster than this, commercially available flashes cannot be used.
- A slower shutter speed may produce blurred images.

**3 Turn on the flash.**

- Be sure to turn on the flash after attaching the flash unit to the camera.

**4 Set the ISO sensitivity and aperture value on the camera to match the flash control mode on the flash.**

- Refer to the flash's manual for instructions on how to set its flash control mode.

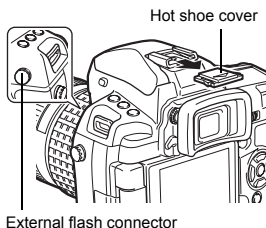

**Notes**

- The flash fires each time the shutter is released. When you do not need to use the flash, turn off the flash's power.
- Check beforehand that the flash you are using is synchronized with the camera.

## Non-specified commercial flashes

- 1) Some commercially available flashes require a voltage of 250V or more for the synchronization connector. The use of this type of flash can damage the camera or prevent the camera from operating properly. Contact the manufacturer of the flash for the specifications of the flash synchronization connector.
- 2) Some commercially available flashes have a synchronization connector with reversed polarity. This type of flash does not work with this camera. Contact the manufacturer of the flash.
- 3) Exposures when using a flash require that adjustments be made on the flash. If a flash is used in the auto mode, match it with the f-number and ISO sensitivity settings on the camera.
- 4) Even if the flash auto f-number and ISO sensitivity are set the same as on the camera, the correct exposure may not be obtained depending on the shooting conditions. In such a case, adjust the auto f-number or ISO on the flash or calculate the distance in the manual mode.
- 5) Use a flash with an illumination angle that matches the focal length of the lens. The focal length of the lens for 35 mm film is approximately twice as long as the focal length of the lenses designed for this camera.
- 6) Do not use a flash unit or other accessory TTL flash that has additional communication functions other than the specified flashes, since it may not only fail to function normally, but may also cause damage to the camera's circuitry.

## Single-frame/Close-up playback



The basic procedure for viewing pictures are as shown below.

However, before using any of these functions, follow Step 1 below. You can set the camera to automatically switch to single-frame playback mode after shooting. "REC VIEW" (P. 100)

### 1 Press the button (Single-frame playback).

- The last recorded image appears.
- The LCD monitor turns off after more than 1 minute if no operations are performed. The camera will turn off automatically if there is no operation after 4 hours (factory default setting). Turn on the camera again.

### 2 Use to select images you want to view. You can also turn the dial to switch to for close-up playback.

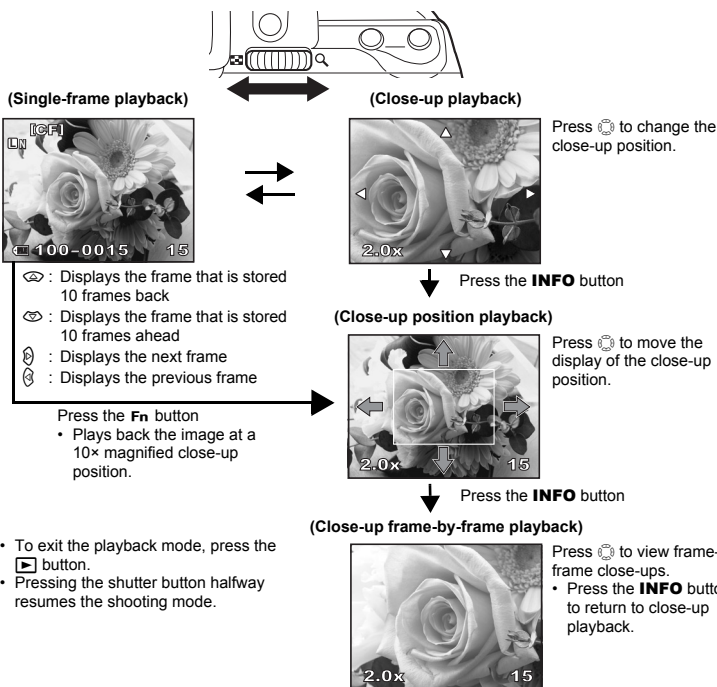
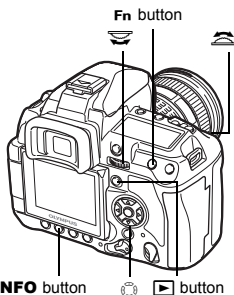

- To exit the playback mode, press the button.
- Pressing the shutter button halfway resumes the shooting mode.

## Light box display

You can view the playback image and another image together on the left and right sides of the monitor. This is useful if you want to compare images you recorded using bracketing.

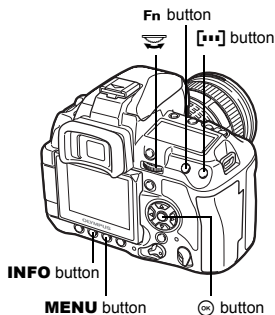

- 1 Press the [L/R] button while viewing an image.**
  - The frame being viewed is displayed on the left side of the monitor, and the next frame is displayed on the right side. The image is displayed at the same magnification of the image being viewed.
  - The image on the left is the benchmark image.
- 2 Use  to select an image.**
  - You can protect, erase or copy the image on the right.
- 3 Press the [L/R] button.**
  - The camera returns to single-frame playback of the image on the left at the magnification being viewed.



7

Playback functions

### Operations during light box display

- Pressing the  button replaces the image on the left with the image on the right and becomes the new benchmark image.
- You can use the dial to change the magnification of both images at the same time.
- Pressing the **Fn** button or **INFO** button allows you to move the position of the image on the right with the  button. Pressing the **Fn** button or **INFO** button again allows you to move the positions of both images with the  button.

 : Selects the right image

 : Scrolls the right image

 : Scrolls both images in synchronization



\* You can also use the **INFO** button in the same way for this procedure.







## Index display/Calendar display



This function lets you show several images on the monitor at the same time. This is useful when you want to quickly search a number of pictures to find a particular image.

During single-frame playback, each time you turn the dial toward , the number of images shown changes from 4 to 9 to 16 to 25.

-  : Moves to the previous frame
-  : Moves to the next frame
-  : Moves to the upper frame
-  : Moves to the lower frame

- To return to single-frame playback, turn the dial to Q.

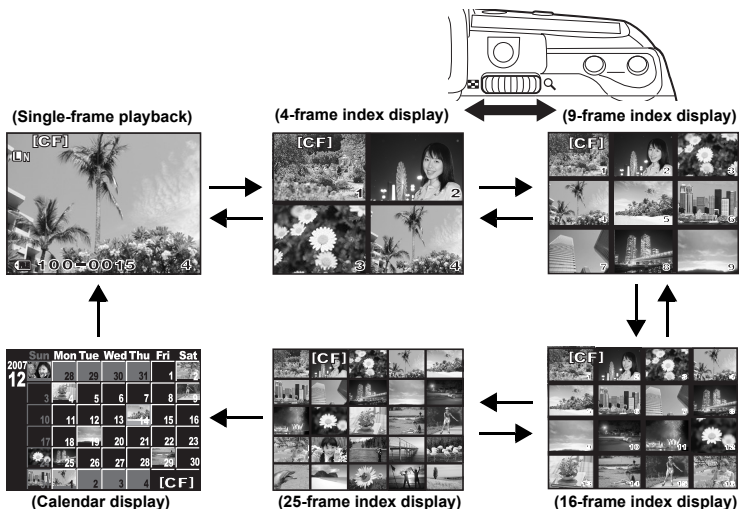
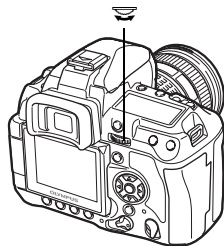



7

Playback functions

### Calendar display

With the calendar, you can display images recorded on the card by date. If more than one image was taken on a single date, the image shot first on that date is displayed.

Use  to select a date and press the  button to play back images for the selected date in single-frame display.

This allows you to display detailed information about the image. Luminance information can also be displayed with histogram and highlight graphs.

Press the **INFO** button repeatedly until the desired information is displayed.

- This setting is stored and will be shown the next time the information display is called up.

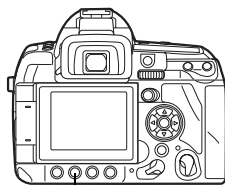

**INFO** button

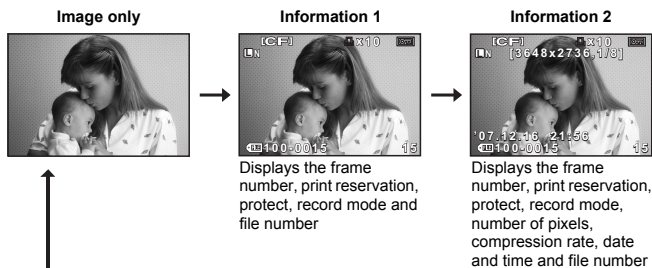

**Image only**

**Information 1**

**Information 2**

Displays the frame number, print reservation, protect, record mode and file number

Displays the frame number, print reservation, protect, record mode, number of pixels, compression rate, date and time and file number

**\*Histogram**

If the bars in the histogram are higher on the right, the image may be too bright. If the bars are higher on the left, the image may be too dark. Compensate the exposure or shoot again.

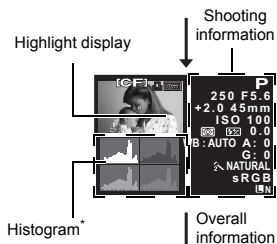

Highlight display

Shooting information

Histogram\*

Overall information



**Shadow display**

**Highlight display**

**Histogram display**

The underexposed (shadowed) parts of the recorded image blink.

The overexposed (highlighted) parts of the recorded image blink.

Distribution of the brightness of the recorded image is displayed in a histogram (brightness component graph).

## Slideshow

This function displays images stored on the card one after another. Images are displayed one by one for about 5 seconds starting from the currently displayed image. Slideshow can be performed using index display. You can select the number of frames displayed during slideshow from 1, 4, 9, 16 or 25.

- 1** MENU ▸ [▶] ▸ [📷]
- 2** Use to set.  
[📷1] (1-frame display)/[📷4] (4-frame display)/[📷9] (9-frame display)/[📷16] (16-frame display)/[📷25] (25-frame display)
- 3** Press the button to start the slideshow.
- 4** Press the button to stop the slideshow.



When selecting [📷4]

### ! Notes

- If the slideshow is left running for about 30 minutes while using the battery, the camera will turn off automatically.

## Rotating images

This function lets you rotate images and display them vertically on the monitor during single-frame playback. This is useful when taking pictures with the camera held vertically. The images will automatically be displayed in the correct direction even if the camera is rotated.

- 1** MENU ▸ [▶] ▸ [📷]
  - When set to [ON], images shot vertically will be automatically rotated and displayed during playback. You can also press the button to rotate and display the image.
  - The rotated image will be recorded on the card in that position.

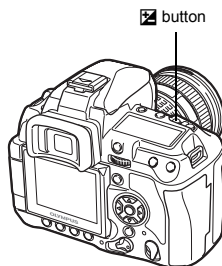

7

Playback functions

Original image  
before rotating

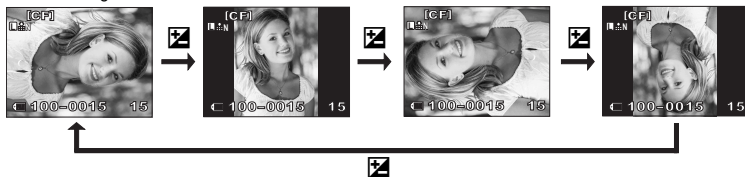

## Playback on TV

Use the video cable provided with the camera to play back recorded images on your TV.

- 1 Turn the camera and TV off, and connect the video cable as illustrated.
- 2 Turn on the TV and set it to the video input mode. For details on switching to the video input mode, refer to the TV's manual.
- 3 Turn the camera on and press the  (playback) button.

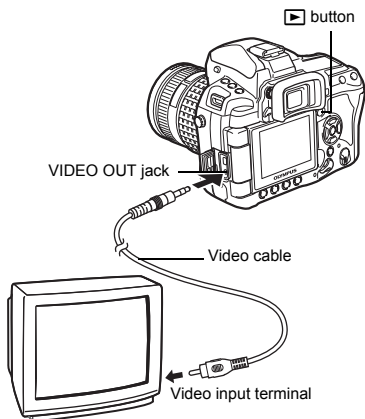

### Notes

- To connect the camera to a TV, use the provided video cable.
- Make sure that the camera's video output signal type is the same as the TV's video signal type.  "VIDEO OUT" (P. 100)
- The camera's monitor turns off automatically when the video cable is connected to the camera.
- The image may appear off-center depending on the TV screen.

7

Playback functions

## Editing still images

Recorded images can be edited and saved as new images. Available editing functions depend on the image format (image record mode). A JPEG file can be printed as is without modification. A RAW file, on the other hand cannot be printed as is. To print a RAW file, use the RAW edit function to convert the RAW data format to JPEG.

### Editing images recorded in RAW data format

The camera performs image processing (such as white balance and sharpness adjustment) on images in the RAW data format, then saves the data to a new file in the JPEG format. While checking recorded images, you can edit them to your liking.

**Image processing is performed based on the current camera settings. Change the camera settings to suit your preferences before editing.**

### Editing images recorded in JPEG data format

 Converts the image file size to 1280 × 960, 640 × 480 or 320 × 240.  
**[SHADOW ADJ]** Brightens a dark backlit subject.

- 1 MENU** > [ ] > [EDIT]
- 2** Use [ ] to select an image, then press the [OK] button.
  - The camera recognizes the image data format.
  - For images recorded in RAW+JPEG, a selection screen will appear, asking you which data to edit.
- 3** The setting screen varies with the image data format. Select the item you want to edit and do the following steps.

Confirm the data format from here.

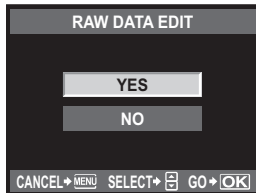

- The edited image is saved as another image, apart from the original image.
- To exit the edit mode, press the **MENU** button.

### ! Notes

- Editing of a JPEG image is not possible in the following cases:  
When an image is recorded in RAW, when an image is processed on a PC, when there is not enough space in the card memory, when an image is recorded on another camera
- When resizing ([ ]), an image, you cannot select a larger number of pixels than was originally recorded.

## Copying images

**COPY**

7

Playback functions

This function lets you copy images to and from the xD-Picture Card and CompactFlash or Microdrive. This menu can be selected if both cards are inserted. The selected card is the copying source. [ ] "CF/xD" (P. 99)

### Single-frame copy





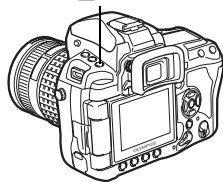



- 1** Play back the image you want to copy and press the **COPY**/[ ] button.
- 2** Use [ ] to select [YES], then press the [OK] button.

**COPY**/[ ] button







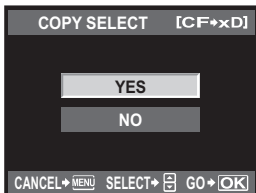

## Copying selected frames

This function lets you select multiple images and copy them all at the same time during single-frame playback or index display.

- 1 Display the images you want to copy and press the  button.
  - The selected images will be shown with red frames.
  - To cancel your selection, press the  button again.
- 2 Press  to display the next images you want to copy and press the  button.
- 3 After you have selected the images to copy, press the **COPY**/ button.
- 4 Use   to select [YES], then press the  button.



- 1 **MENU**    **[COPY ALL]**
- 2 Press .
- 3 Use   to select [YES], then press the  button.

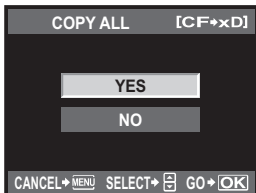



## Protecting images



Protect images you do not want to erase. Protected images cannot be erased by the single-frame or all-frame erase function.

### Single-frame protect

Play back the image you want to protect and press the  button.

-  (protect mark) is displayed on the top right corner of the screen.





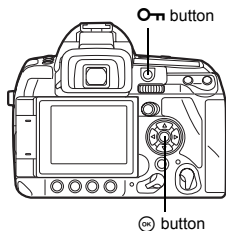

### To cancel the protection

Display the images that are protected and press the  button.









## Protecting selected frames

This function lets you select multiple images and protect them all at the same time during single-frame playback or index display.

- 1 Display the images you want to protect and press the  button.**
  - The selected images will be shown with red frames.
  - To cancel your selection, press the  button again.
  - During index display, press  to select the images you want to protect and press the  button.
- 2 Press  to display the next images you want to protect and press the  button.**
- 3 After you have selected the images to protect, press the  button.**

## Canceling all protections



This function lets you cancel the protection of several images at one time.

- 1 MENU**  **[▶]**  **[RESET PROTECT]**
  - 2 Use   to select [YES], then press the  button.**
- !** **Notes**
- Formatting the card erases all images even if they have been protected.  
 "Formatting the card" (P. 125)
  - Protected images cannot be rotated even when the  button is pressed.





## Erasing images



Lets you erase recorded images. You can select single-frame erase, which erases only the currently displayed image; all-frame erase, which erases all the images stored on the card; or selected frame erase, which erases only the frames selected.

- !** **Notes**
- When you perform all-frame or selected frame erase on images recorded using RAW+JPEG, both the RAW and JPEG images are erased. When using single-frame erase, you can select whether to erase the JPEG, RAW, or both RAW and JPEG images.  "RAW+JPEG ERASE" (P. 98)
  - Protected images cannot be erased. Cancel protected images, then erase them.
  - Once erased, images cannot be restored.  "Protecting images" (P. 86)





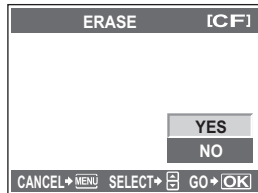
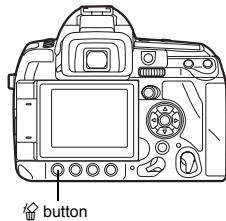





## Single-frame erase

- 1 Play back the image you want to erase and press the  button.
- 2 Use   to select [YES], then press the  button.



## Erasing selected frames

This function lets you erase selected images at one time during single-frame playback or index display.

- 1 Display the images you want to erase and press the  button.
  - The selected images will be shown with red frames.
  - To cancel your selection, press the  button again.
  - During index display, press  to select the images you want to erase and press the  button.
- 2 Press  to display the next images you want to erase and press the  button.
- 3 After you have selected the images to erase, press the  button.
- 4 Use   to select [YES], then press the  button.

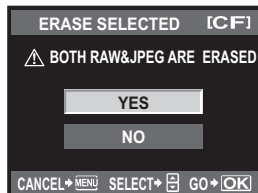



## All-frame erase

- 1 MENU** ▶ [OK] ▶ [CARD SETUP]
- 2** Use to select [ALL ERASE], then press the button.

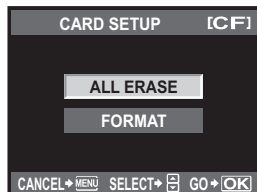

- 3** Use to select [YES], then press the button.
  - All frames will be erased.



### TIPS

#### To erase immediately:

- If you have set "QUICK ERASE" ( P. 98) to [ON], pressing the button will erase an image immediately.
- You can set the initial position of the cursor to [YES]. "PRIORITY SET" (P. 99)

Use the custom menus to customize the camera for ease of use. Use Custom Menu 1 to customize the shooting functions and Custom Menu 2 to set the basic camera functions. Custom Menu 1 has 9 tabs (iA to iI) that are divided according to the functions to be set.

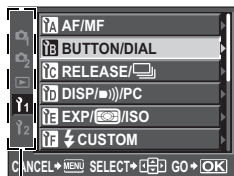

Use to select [iA], then press .

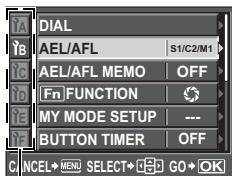

Use to select tab iA to iI, then press .

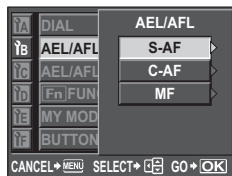

Use to select a function, then press .

For details on using the menu lists, see “Using the menu” (P. 29).

## Custom Menu 1 ▶ iA AF/MF

### AF ILLUMINAT.

The built-in flash can function as an AF illuminator. This helps with focusing in low-light conditions in the AF mode. To use this function, raise the flash.

### FOCUS RING

You can customize how the lens adjusts to the focal point by selecting the rotational direction of the focus ring.

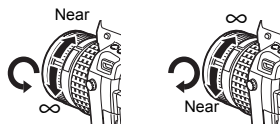

### C-AF LOCK

When set to [ON], during focusing with C-AF mode, this prevents the focus from changing even if the distance to the subject suddenly changes. This is effective when shooting at a location where something passes in front of or behind the subject.

### AF AREA POINTER

When set to [OFF], the AF target does not light in the viewfinder when the subject is in focus.

### AF SENSITIVITY

You can set the range of the AF target for focusing when [AF AREA] is set to [·].

**[NORMAL]** The camera focuses using a range that is somewhat larger than the selected AF target.

**[SMALL]** The camera focuses only within the selected AF target. When [SMALL] is selected, the setting display for [AF AREA] becomes [·]s.

## [...] SET UP

Selects the operation of the dials or arrow pad when selecting the AF target.

- [OFF]** Stops after moving to the AF target on the end.
- [LOOP]** After moving to the AF target on the end, moves to the AF target on the opposite end of the same row or column. Selects all AF targets before moving to the AF target on the opposite end, and **[AF AREA]** is set to [:::].
- [SPIRAL]** After moving to the AF target on the end, moves to the AF target on the opposite end of the next row or column. Selects all AF targets before moving to the AF target on the opposite end, and **[AF AREA]** is set to [:::].

e.g.) When moving from the top left AF target to the right

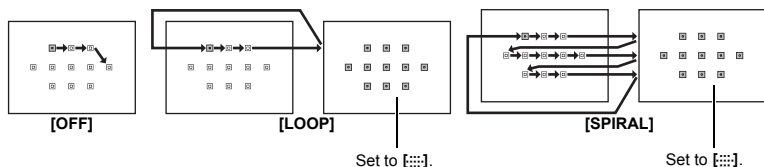

## RESET LENS

When set to **[ON]**, this resets the focus of the lens (infinity) each time the power is turned off.

## BULB FOCUSING

You can set the camera to enable focus adjustments during bulb shooting with MF.

- [ON]** During exposure, you can turn the focus ring and adjust the focus.
- [OFF]** The focus is locked during exposure.

## Custom Menu 1 ▶ [B] BUTTON/DIAL

### DIAL

In **P**, **A**, **S**, or **M** mode, you can assign functions other than the default functions to the main dial and sub dial. You can also switch the operations of the main dial and sub dial for menu operations with the default operations.

- P** : [Ps]/[Z]/[Z]
- A** : [FNo.]/[Z]/[Z]
- S** : [SHUTTER]/[Z]/[Z]
- M** : [SHUTTER]/[FNo.]
- MENU** : [◀]/[▶ / VALUE]

- [◀] on **[MENU]** means the horizontal operation of the dial (the same as pressing ). [▶ / VALUE] means the vertical operation of the dial (the same as pressing ).

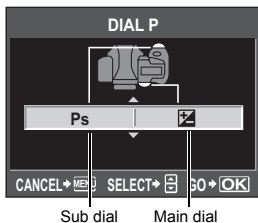

Sub dial Main dial

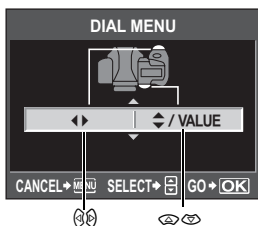

## AEL/AFL

You can use the **AEL/AFL** button to perform AF or metering operations instead of using the shutter button.

Select the function of the button to match the operation when the shutter button is pressed.

Select **[mode1]** to **[mode4]** in each focus mode. (You can only select **[mode4]** in C-AF mode.)

Mode	Shutter button function				AEL/AFL button function	
	Half-press		Full press		When holding down AEL/AFL	
	Focus	Exposure	Focus	Exposure	Focus	Exposure
<b>[S-AF]</b>						
<b>mode1</b>	S-AF	Locked	—	—	—	Locked
<b>mode2</b>	S-AF	—	—	Locked	—	Locked
<b>mode3</b>	—	Locked	—	—	S-AF	—
<b>[C-AF]</b>						
<b>mode1</b>	C-AF start	Locked	Locked	—	—	Locked
<b>mode2</b>	C-AF start	—	Locked	Locked	—	Locked
<b>mode3</b>	—	Locked	Locked	—	C-AF start	—
<b>mode4</b>	—	—	Locked	Locked	C-AF start	—
<b>[MF]</b>						
<b>mode1</b>	—	Locked	—	—	—	Locked
<b>mode2</b>	—	—	—	Locked	—	Locked
<b>mode3</b>	—	Locked	—	—	S-AF	—

### Basic operations

**[mode1]** For determining the metered exposure while focusing. AE lock is activated while pressing the **AEL/AFL** button, allowing you to adjust the focus and determine the exposure separately.

**[mode2]** For determining the exposure when you press the shutter button fully. This is useful for shooting scenes with significant changes in lighting, such as on a stage.

**[mode3]** For focusing with the **AEL/AFL** button instead of the shutter button.

**[mode4]** Press the **AEL/AFL** button to focus, and press the shutter button fully to determine the exposure.

### AEL/AFL MEMO

You can lock and maintain the exposure by pressing the **AEL/AFL** button.

**[ON]** Press the **AEL/AFL** button to lock and maintain the exposure. Press again to cancel the maintaining of the exposure.

**[OFF]** The exposure will be locked only while the **AEL/AFL** button is pressed.

### **[Fn]** FUNCTION

You can assign a function to the **Fn** button.

**[PREVIEW]/[LIVE PREVIEW] (electronic)**

While holding down the **Fn** button, you can use the preview function.

 "Preview function" (P. 45)



Press the **Fn** button to acquire the WB value. “Setting the one-touch white balance” (P. 65)

#### [] HOME

Press the **Fn** button to switch to the registered AF home position. Press the button again to switch to the original AF target mode. “Registering an AF target mode” (P. 55)

#### [MF]

Press the **Fn** button to switch AF mode to [MF]. Press the button again to switch to the original AF mode.

#### [RAW ]

Press the **Fn** button to switch from JPEG to RAW+JPEG or from RAW+JPEG to JPEG for the record mode.

You can change the record mode by turning the main dial/sub dial while holding down the **Fn** button.

#### [P/A/S/M]

You can change the shooting mode by turning the main dial/sub dial while holding down the **Fn** button.

#### [TEST PICTURE]

Pressing the shutter button while pressing the **Fn** button enables you to check the picture you have just taken on the monitor without having to record the picture to the card. This is useful when you want to see how a picture turned out without saving it.

#### [MY MODE]

While holding down the **Fn** button, you can take pictures using the camera settings registered in the [MY MODE SETUP]. “MY MODE SETUP” (P. 93)

#### [/]

Press the **Fn** button to switch to under water wide and to switch between under water wide and under water macro. Alternatively, turn the main dial while holding down the **MODE** button to select under water wide or under water macro. “Under water wide/macro shooting” (P. 44)

#### [OFF]

Does not allow function allocation.

## MY MODE SETUP

You can store two frequently used settings as My Mode. There are two basic ways to shoot with the registered My Mode settings.

- Use the **MODE** button to make the settings. “My Mode shooting” (P. 44)
  - Assign [MY MODE SETUP] to the **Fn** button. “[Fn] FUNCTION” (P. 92)
- To shoot with My Mode using the **Fn** button, follow the steps under “Executing” below and set the My Mode you will use in advance.

### Registering

- 1) Select [MY MODE1] or [MY MODE2] and press .
- 2) Select [SET] and press the button.
  - The current settings are registered in the camera. For details on the functions that can be registered to My Mode, refer to “Functions that can be registered with My Mode and Custom Reset Setting” ( P. 134).
  - To cancel the registration, select [RESET].

### Executing

- 1) Select [MY MODE1] or [MY MODE2] and press the button.
- 2) Select [YES] and press the button.
  - The selected My Mode is set.
  - When shooting, press the shutter button while holding down the **Fn** button.

## BUTTON TIMER

---

The direct button may remain selected even after it is released.

- [OFF]** Available only when the button is pressed.
- [3SEC]/[5SEC]/[8SEC]** The button remains selected during the number of seconds indicated.
- [HOLD]** The button remains selected until you press it again.

• Buttons that can be set with **[BUTTON TIMER]**

**ISO**, **WB**, **Flash**, **MODE**, **AF**, **BKT**,



---

You can switch the functions of the **AEL/AFL** button and the **Fn** button. When you select **[ON]**, the **AEL/AFL** button will function as the **Fn** button, and the **Fn** button will function as the **AEL/AFL** button.

- The setting also applies to the **Fn** button on the optional power battery holder when attached to the camera.

## Custom Menu 1 ▶ RELEASE/

---

### RLS PRIORITY S/RLS PRIORITY C

---

Normally, this camera does not release the shutter while the AF is operating or the flash is charging. If you want to release the shutter without waiting until these operations have completed, use the setting below. You can set the release priority individually in AF mode.

RLS PRIORITY S Sets release priority for S-AF mode P. 51.

RLS PRIORITY C Sets release priority for C-AF mode P. 52.



---

You can set the number of pictures shot in one second when using sequential shooting with from **[1fps]** to **[4fps]**.

8

## Custom Menu 1 ▶ DISP/

---



---

You can turn off the beep sound that is emitted when the focus locks by pressing the shutter button.

### SLEEP

---

After a specified period of time elapses with no operations being performed, the camera enters the sleep mode (stand-by) to save battery power. After the super control panel is displayed for a specified period of time, the backlight turns off. After a specific period of time has further passed, the camera enters sleep mode. **[SLEEP]** lets you select sleep timer from **[1MIN]**, **[3MIN]**, **[5MIN]**, or **[10MIN]**. **[OFF]** cancels the sleep mode.

The camera activates again as soon as you touch any button (the shutter button, arrow pad, etc.).

## BACKLIT LCD (Backlight timer)

---

To save battery power, after the super control panel is displayed for a specified period of time, the monitor backlight turns off and the monitor darkens. Select from **[8SEC]**, **[30SEC]**, or **[1MIN]** for the time until the backlight turns off. **[HOLD]** sets the backlight to stay on. The monitor backlight turns on again as soon as you touch any button (the shutter button, arrow pad, etc.).

## 4 h TIMER (Auto power off)

---

You can set the camera to turn off automatically if not operated for 4 hours. It will not turn off if this is set to **[OFF]**.

## USB MODE

---

You can connect the camera directly to a computer or printer with the provided USB cable. If you specify the device you are connecting to beforehand, you can skip the USB connection setting procedure normally required every time you connect the cable to the camera. For details on how to connect the camera to either device, refer to "Connecting the camera to a printer" (📖 P. 104) and "Connecting the camera to a computer" (📖 P. 108).

### [AUTO]

The selection screen for the USB connection will be displayed every time you connect the cable to a computer or printer.

### [STORAGE]

Allows you to transfer images to a computer. Also, select to use the OLYMPUS Master software via PC connection.

### [MTP]

Allows you to transfer images to a computer running Windows Vista without using the OLYMPUS Master software.

### [CONTROL]

Allows you to control the camera from a PC using the optional OLYMPUS Studio.

### [🖨️] EASY

Can be set when connecting the camera to a PictBridge-compatible printer. Pictures can be printed directly without using a PC. 📖 "Connecting the camera to a printer" (P. 104)

### [🖨️] CUSTOM

Can be set when connecting the camera to a PictBridge-compatible printer. You can print out pictures with set number of prints, print paper and other settings. 📖 "Connecting the camera to a printer" (P. 104)

## LIVE VIEW BOOST

---

During live view shooting, you can brighten the monitor for easier confirmation on the subject.

### [OFF]

The subject is displayed on the monitor with the brightness level that is adjusted according to the exposure being set. You can shoot while confirming through the monitor in advance to get a picture that is to your liking.

### [ON]

The camera automatically adjusts the brightness level and displays the subject on the monitor for easier confirmation. The effect of the exposure compensation adjustments will not be reflected on the monitor.

## FRAME ASSIST (Ruled lines display)

---

You can display the ruled lines on the LCD monitor as a guide when confirming the composition. Press the **INFO** button repeatedly to display the ruled lines. 📖 "Switching the information display" (P. 32)

## Custom Menu 1 ▶ /ISO

### EV STEP

You can select the EV step for exposure parameter setting, such as shutter speed, aperture value, or exposure compensation value, from **[1/3EV]**, **[1/2EV]**, or **[1EV]**.

### ISO STEP

You can select the EV step of the ISO sensitivity from **[1/3EV]** or **[1EV]**.

### ISO-AUTO SET

You can set the upper limit and default ISO values when ISO is set to **[AUTO]**.

#### **[HIGH LIMIT]**

This sets the upper limit of the ISO value that automatically changes. The upper limit can be set from 100 to 3200 in 1/3 EV increments.

#### **[DEFAULT]**

This sets the value to be normally used when the optimum exposure can be obtained. The value can be set from 100 to 3200 in 1/3 EV increments.

### ISO-AUTO

You can set the shooting mode in which the ISO **[AUTO]** setting is activated.

#### **[P/A/S]**

In **P/A/S** mode, the **[AUTO]** setting is activated. When **[AUTO]** is set in other shooting modes, ISO 100 is set.

#### **[ALL]**

The **[AUTO]** setting is activated for all shooting modes. The ISO is automatically selected to obtain the optimal ISO even in **M** mode.

### AEL Metering

You can set the metering mode when pressing the **AEL/AFL** button to lock the exposure.

- **[AUTO]** performs metering in the mode selected under **[METERING]**.

### BULB TIMER

You can select the maximum time (in minutes) for bulb shooting.

## Custom Menu 1 ▶ CUSTOM

### X-SYNC.

You can set the shutter speed that will be used when the flash fires. The speed can be set from 1/60 to 1/250 in 1/3 EV increments.

- For details on the synchronization speed of commercially available flashes, refer to their manuals.

### SLOW LIMIT

You can set the slow limit of the shutter speed that will be used when the flash fires. The speed can be set from 1/30 to 1/250 in 1/3 EV increments.

### +

When set to **[ON]**, it will be added to the exposure compensation value and flash intensity control will be performed.



### ALL [WB%]

You can apply the same compensation value to all the white balance modes at once.

**[ALL SET]** The same compensation value applies to all WB modes.

**[ALL RESET]** The WB compensation value settings applied to each WB mode are all cleared at once.

#### If you select [ALL SET]

- Use to select the color direction.  
Toward A: Amber-Blue/Toward G: Green-Magenta
- Use to set the compensation value. "WB compensation" (P. 64)  
Releasing the **AEL/AFL** button takes a sample image. You can check the white balance you have adjusted.

#### If you select [ALL RESET]

- Use to select [YES].

## COLOR SPACE

You can select how colors are reproduced on the monitor or printer. The first character in image file names indicates the current color space. "FILE NAME" (P. 98)

Pmdd0000.jpg	[sRGB]	Standardized color space for Windows.
└─┬─ P : sRGB	[Adobe RGB]	Color space that can be set with Adobe Photoshop.
└─┬─ _ : Adobe RGB		

## SHADING COMP.

In some cases, the edges of the image may be shadowed due to the properties of the lens. The shading compensation function compensates by increasing brightness at the dark edge of the image. This function is especially useful when a wide-angle lens is used.

### ! Notes

- This function is not available when a teleconverter or an extension tube is attached to the camera.
- At higher ISO settings, noise in image edges may be conspicuous.

## ⏪- SET

You can combine 3 image sizes and 4 compression rates and register 4 combinations. Select the registered setting with . "Selecting the record mode" (P. 61)

Register 4 different combinations of image settings.

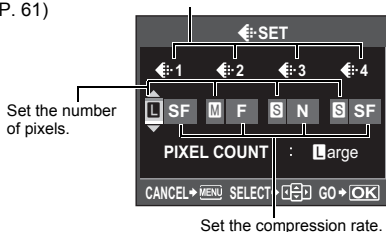

## PIXEL COUNT

You can set the pixel size for the image size [M], [S].

[M]iddle Select [3200 × 2400], [2560 × 1920], or [1600 × 1200].

[S]mall Select [1280 × 960], [1024 × 768], or [640 × 480].

## Custom Menu 1 ▶ [M] RECORD/ERASE

### QUICK ERASE

You can erase the picture you have just taken immediately using the  button.

[OFF] When the  button is pressed, the confirmation screen appears, asking you if you want to erase the picture.

[ON] Pressing the  button erases the picture immediately.

### RAW+JPEG ERASE

You can select the method to erase images recorded in RAW+JPEG. This function can only be used to erase one frame.

[JPEG] Erases all JPEG image files, leaving only the RAW image files.

[RAW] Erases all RAW image files, leaving only the JPEG image files.

[RAW+JPEG] Erases both image file types.

### ! Notes

- This function is effective only if deleting one frame. For all-frame erase or erasing selected frames, both RAW and JPEG will be erased regardless of this setting.

### FILE NAME

When you take a picture, the camera assigns it a unique file name and saves it in a folder. File names are assigned as shown in the illustration below.

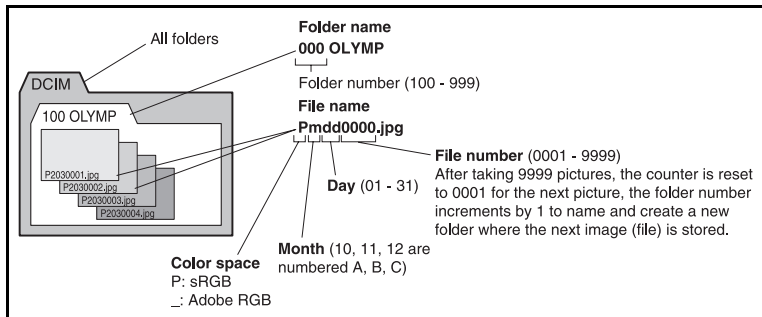

## [AUTO]

Even when a new card is inserted, the folder numbers are retained from the previous card. If the new card contains an image file whose file number coincides with one saved on the previous card, the new card's file numbers start at the number following the highest number on the previous card.

## [RESET]

When a new card is inserted, folder numbers start at 100 and file numbers start at 0001. If a card containing images is inserted, the file numbers start at the number following the highest file number on the card.

- When both the Folder and File No. reach their respective maximum number (999/9999), it is not possible to store additional pictures even if the card is not full. No more pictures can be taken. Replace the card with a new one.

## PRIORITY SET

---

You can customize the initial position of the cursor ([YES] or [NO]) on the [ALL ERASE] or [FORMAT] screen.

## dpi SETTING

---

You can set the resolution for printing images in advance. The set value is recorded on the card with the images.

[AUTO] Automatically set according to the image size.

[CUSTOM] You can make the desired setting. Press  to display the setting screen.

## Custom Menu 1 ▶ UTILITY

---

### EXT. WB DETECT

---

You can disable the white balance sensor used to determine the light source during auto white balance. This is useful when the light source near the sensor and the light source illuminating the subject are different.

## Custom Menu 2

---

### CF/xD

---

You can select which card to use when both a CompactFlash and xD-Picture Card are loaded.

### EDIT FILENAME

---

You can rename image files to make them easier to identify and organize. The portion of the filename that can be changed depends on the color space.  "COLOR SPACE" (P. 97)

sRGB : Pmdd0000.jpg

AdobeRGB : \_mdd0000.jpg

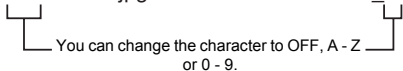



### (Monitor brightness adjustment)

---

You can adjust the brightness of the monitor for optimal viewing.

[AUTO] This allows the illumination sensor to measure the surrounding brightness and automatically adjust the monitor for optimal viewing.

[+7] - [-7] Use   to adjust the monitor brightness.

## (Changing the display language)

You can change the language used for the on-screen display and error messages from ENGLISH to another language.

- You can add another language to your camera with the provided OLYMPUS Master software.  
For details, refer to Help in OLYMPUS Master software.  “Using the OLYMPUS Master software” (P. 107)

## VIDEO OUT

You can select NTSC or PAL according to your TV's video signal type. You will need to set this when you want to connect the camera to a TV and play back images in a foreign country. Make sure the correct video signal type is selected before connecting the video cable. If you use the wrong video signal type, recorded pictures will not play back properly on your TV.

### TV video signal types in major countries and regions

Check the video signal type before connecting the camera to your TV.

NTSC	North America, Japan, Taiwan, Korea
PAL	European countries, China

## REC VIEW

You can display the picture you have just taken on the monitor while it is being recorded to the card, and to select how long the picture is displayed. This is useful for making a brief check of the picture you have just taken. Pressing the shutter button halfway while checking the picture lets you resume shooting immediately.

**[1SEC] – [20SEC]** Selects the number of seconds to display each picture. Can be set in units of 1 second.

**[OFF]** The picture being recorded to the card is not displayed.



**[AUTO ** Displays the image being recorded, and then switches to playback mode. This is useful for erasing a picture after checking it.

## 8

## FIRMWARE

Your product's firmware version will be displayed.

When you make inquiries about your camera or accessories or when you want to download software, you will need to state which version of each of the products you are using.

Press . Your product's firmware version will be displayed. Press the  button to return to the previous screen.

## Print reservation (DPOF)



### Print reservation

Print reservation allows you to save printing data (the number of prints and the date/time information) with the pictures stored on the card.

Pictures set with print reservation can be printed using the following methods.

#### Printing using a DPOF-compatible photo lab

You can print the pictures using the print reservation data.

#### Printing using a DPOF-compatible printer

Pictures can be printed directly from a dedicated printer without using a PC. For more details, refer to the printer's manual. A PC card adapter may also be necessary.

#### Notes

- DPOF reservations set by another device cannot be changed by this camera. Make changes using the original device. Moreover, setting new DPOF reservations using this camera will erase the previous reservations set by another device.
- Not all functions may be available on all printers or at all photo labs.
- RAW data are not printable.

### Single-frame reservation

Follow the operation guide to set print reservation for a picture.

#### 1 MENU ▸ [▶] ▸ [⏏]

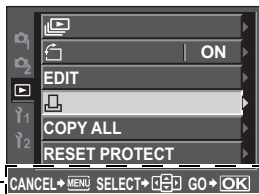

Operation guide — CANCEL → MENU SELECT → [DPOF] GO → OK

#### 2 Select [⏏] and press the [OK] button.

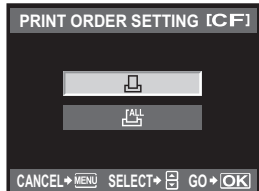

CANCEL → MENU SELECT → [DPOF] GO → OK

#### 3 Press [OK] to select the frame that you want to set as print reservation, then press [▶] [▶] to set the number of prints.

- To set print reservation for several pictures, repeat this step.

#### 4 Press the [OK] button when you have finished.

- The menu screen for single-frame reservation appears.



CANCEL → MENU SELECT → [DPOF] GO → OK

**5 Select the date and time format and press the  button.**

**[NO]** The pictures are printed without the date and time.

**[DATE]** The pictures are printed with the shooting date.

**[TIME]** The pictures are printed with the shooting time.

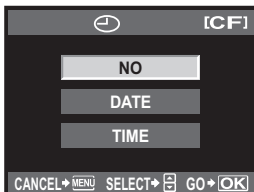

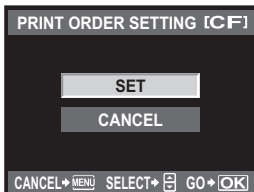

**6 Select [SET] and press the  button.**



## All-frame reservation

Applies print reservation to all the pictures stored in the card. The number of prints is fixed at 1.

**1 MENU**   

**2 Select  and press the  button.**

**3 Select the date and time format and press the  button.**

**[NO]** The pictures are printed without the date and time.

**[DATE]** The pictures are printed with the shooting date.

**[TIME]** The pictures are printed with the shooting time.

**4 Select [SET] and press the  button.**

## Resetting the print reservation data

You can reset all print reservation data or just the data for selected pictures.

9

**1 MENU**   







### Resetting the print reservation data for all pictures

**2 Select  or  and press the  button.**

**3 Select [RESET] and press the  button.**



## Resetting the print reservation data for a selected picture

- 2 Select [ ] and press the  button.
- 3 Select [KEEP] and press the  button.
- 4 Use  to select the frame with print reservation data you want to reset, then press  to set the number of prints to 0.
- 5 Press the  button when you have finished.
- 6 Select the date and time format and press the  button.
  - This setting is applied to all frames with print reservation data.
- 7 Select [SET] and press the  button.

## Direct printing (PictBridge)



By connecting the camera to a PictBridge-compatible printer with the USB cable, you can print out recorded pictures directly. To find out if your printer is compatible with PictBridge, refer to the printer's manual.

### PictBridge

The standard that enables digital cameras and printers made by different manufacturers to be connected, and also allows pictures to be printed directly from the camera.

### STANDARD

All printers that support PictBridge have standard print settings. By selecting [STANDARD] on the settings screens ( P. 105), you can print pictures according to these settings. For details on your printer's standard settings, refer to the printer's manual or contact the printer manufacturer.

- The available print modes and settings such as paper size vary with the type of printer. For details, refer to the printer's manual.
- For details on printing paper types, ink cassettes, etc., refer to the printer's manual.

### Notes

- Use a fully charged battery for printing.
- Images recorded in RAW data cannot be printed.
- The camera will not enter sleep mode while it is connected to the USB cable.

## Connecting the camera to a printer

Use the provided USB cable to connect the camera to a PictBridge-compatible printer.

- 1 Turn the printer on and connect the camera's USB connector to the printer's USB port with the USB cable.
  - For details on how to turn the printer on and the position of the USB port, refer to the printer's manual.

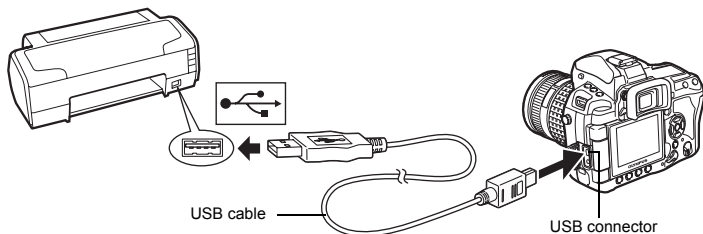

- 2 Turn on the camera.
  - The selection screen for the USB connection is displayed.
- 3 Use  to select [EASY PRINT] or [CUSTOM PRINT].

### If you select [EASY PRINT]

- Go to "Easy printing" ( P. 104)

### If you select [CUSTOM PRINT]

- [ONE MOMENT] is displayed and the camera and printer are connected.  
GO to "Custom printing" ( P. 105)

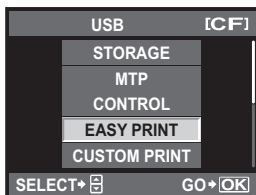

### Notes



- If the screen is not displayed after a few minutes, disconnect the USB Cable and start again from Step 1.

## Easy printing

- 1 Use  to display the pictures you want to print on the camera.

- Display the image you want to print on the camera and connect the camera with a printer using a USB cable. The screen on the right appears shortly.

- 2 Press the  (print) button.

- The picture selection screen appears when printing is completed. To print another picture, use  to select the image and press the  button.
- To exit, unplug the USB cable from the camera while the picture selection screen is displayed.

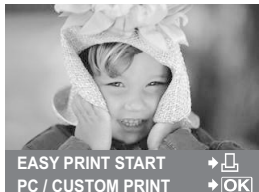



### 1 Follow the operation guide to set a print option.

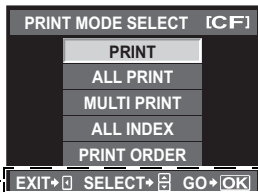

Follow the operation guide displayed here.

#### Selecting the print mode

Select the type of printing (print mode). The available print modes are as shown below.

- [PRINT]** Prints selected pictures.
- [ALL PRINT]** Prints all the pictures stored in the card and makes one print for each picture.
- [MULTI PRINT]** Prints multiple copies of one image in separate frames on a single sheet.
- [ALL INDEX]** Prints an index of all the pictures stored in the card.
- [PRINT ORDER]** Prints according to the print reservation you made. If there is no picture with print reservation, this is not available. (P. 101)

#### Setting the print paper items

This setting varies with the type of printer. If only the printer's STANDARD setting is available, you cannot change the setting.

- [SIZE]** Sets the paper size that the printer supports.
- [BORDERLESS]** Selects whether the picture is printed on the entire page or inside a blank frame.
- [PICS/SHEET]** Selects the number of pictures per sheet. Displayed when you have selected **[MULTI PRINT]**.

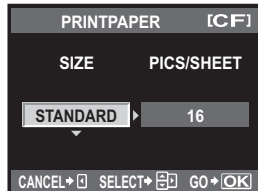
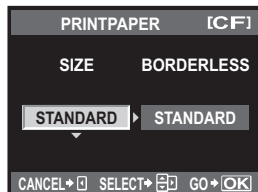

## Selecting pictures you want to print

Select pictures you want to print. The selected pictures can be printed later (single-frame reservation) or the picture you are displaying can be printed right away.

**[PRINT] [OK]**

Prints the currently displayed picture. If there is a picture that **[SINGLE PRINT]** reservation has already been applied to, only that reserved picture will be printed.

**[SINGLE PRINT] [▲]**

Applies print reservation to the currently displayed picture. If you want to apply reservation to other pictures after applying **[SINGLE PRINT]**, use **[◀]** to select them.

**[MORE] [▼]**

Sets the number of prints and other items for the currently displayed picture, and whether or not to print it. For operation, refer to "Setting printing data" (P. 106) in the next section.



## Setting printing data

Select whether to print printing data such as the date and time or file name on the picture when printing.

**[ ]x**

Sets the number of prints.

**[DATE]**

Prints the date and time recorded on the picture.

**[FILE NAME]**

Prints the file name recorded on the picture.

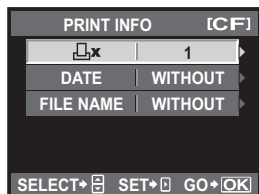

## 2 Once you have set the pictures for printing and printing data, select **[PRINT]**, then press the **[⊖]** button.

**[PRINT]**

Transfers images you print to the printer.

**[CANCEL]**

Resets the settings. All print reservation data will be lost. If you want to keep the print reservation data and make other settings, press **[◀]**. This returns you to the previous setting.

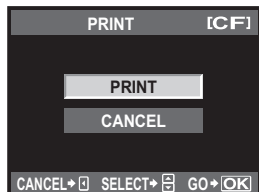

- To stop and cancel printing, press the **[⊖]** button.

**[CONTINUE]**

Continues printing.

**[CANCEL]**

Cancels printing. All print reservation data will be lost.

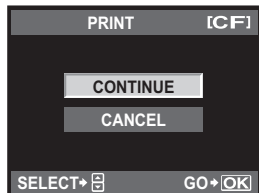

## Flowchart

Just connect the camera to a computer with the USB cable and you can easily transfer images stored on the card to the computer with the provided OLYMPUS Master software.

### Things to prepare

- OLYMPUS Master 2 CD-ROM
- USB cable
- Computer that fulfills the operating environment  
(For the required operating environment, refer to the OLYMPUS Master installation guide.)

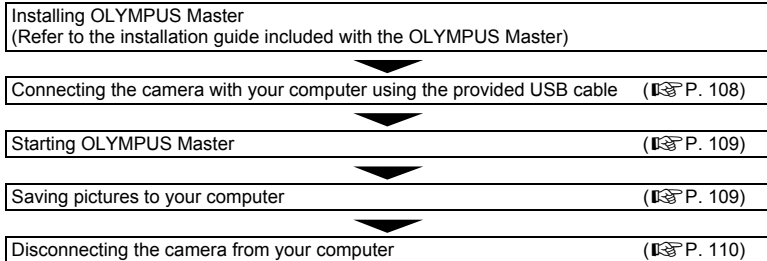

## Using the provided OLYMPUS Master software

### What is OLYMPUS Master?

OLYMPUS Master is an image management program with viewing and editing features for pictures taken with your digital camera. Once installed on your computer, you can take advantage of the following.

- **Transferring images from the camera or removable media to your computer**
- **Viewing images**  
You can also enjoy slideshows and sound playback.
- **Grouping and organizing images**  
You can organize images into albums or folders. Transferred images are automatically organized by shooting date, allowing you to quickly find the particular images you want.
- **Correcting images using filter and correction functions**
- **Editing images**  
You can rotate, trim or change the image size.
- **A variety of printing formats**  
You can easily make prints of your pictures.
- **Updating the camera firmware**
- **Developing RAW images**

For information about OLYMPUS Master's other features, as well as for details on how to use the software, refer to "Help" in OLYMPUS Master software.

# Connecting the camera to a computer

Connect the camera to your computer with the provided USB cable.

## 1 Use the provided USB cable to connect the computer's USB port to the camera's USB connector.

- The location of the USB port varies with the computer. For details, refer to your computer's manual.

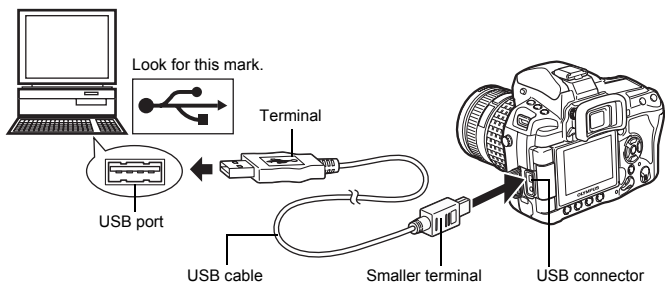

## 2 Set the camera's power switch to ON.

- The selection screen for the USB connection is displayed.

## 3 Press $\leftarrow$ $\rightarrow$ to select [STORAGE]. Press the $\text{OK}$ button.

## 4 The computer recognizes the camera as a new device.

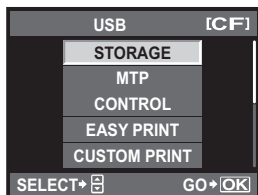

### Windows

- When you connect the camera to the computer for the first time, the computer automatically recognizes the camera. Click "OK" when the message saying that the installation is completed appears. The computer recognizes the camera as a "Removable Disk ".

### Macintosh

- iPhoto is the default image management application for Mac OS. When you connect your Olympus digital camera for the first time, iPhoto will start up automatically. Close iPhoto and start OLYMPUS Master.

## ! Notes

- When the camera is connected to the computer, none of the camera buttons are functional.

# Start up the OLYMPUS Master software

## Windows

- 1 Double-click the “OLYMPUS Master 2” icon  on the desktop.

## Macintosh



- 1 Double-click the “OLYMPUS Master 2” icon  in the “OLYMPUS Master 2” folder.
  - The browse window is displayed.
  - When OLYMPUS Master is started up for the first time after installation, the OLYMPUS Master initial setting screen and user registration screen are displayed before the browse window. Follow the on-screen instructions.

## To exit OLYMPUS Master

- 1 Click “Exit”  on any window.
  - OLYMPUS Master is exited.

# Displaying camera images on a computer

## Downloading and saving images

- 1 Click “Transfer Images”  on the browse window, and then click “From Camera” .
  - The window for selecting the pictures you want to transfer from the camera is displayed. All the images in the camera are displayed.
- 2 Select “New Album” and enter an album name.
- 3 Select the image files and click “Transfer Images”.
  - A window indicating that the download is complete is displayed.
- 4 Click “Browse images now”.
  - The downloaded images are displayed in the browse window.



## Disconnecting the camera from your computer

- 1 Make sure that the card access lamp has stopped blinking.

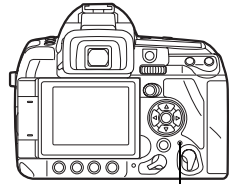

Card access lamp

- 2 Prepare to remove the USB cable.

### Windows

- 1) In the system tray, click the "Unplug or Eject Hardware" icon .
- 2) Click on the pop-up message.
- 3) Click "OK" on the "Safe to Remove Hardware" window.

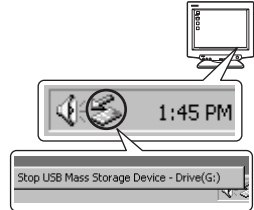

Click

### Macintosh

- 1) The trash icon changes to the eject icon when the "Untitled" or "NO\_NAME" icon on the desktop is dragged. Drag and drop it on the eject icon.

- 3 Unplug the USB cable from the camera.



- Notes

- For Windows users:

When you click "Unplug or Eject Hardware", a warning message may be displayed. In such case, make sure that no image data is being downloaded from the camera, and that there are no applications open that were accessing the camera image files. Close any such applications and click "Unplug or Eject Hardware" again and then remove the cable.



## Viewing still images

- 1 Click the “Album” tab on the browse window and select the album that you want to view.
  - The selected album image is displayed in the thumbnail area.
- 2 Double-click the still picture thumbnail that you want to view.
  - OLYMPUS Master switches to the image edit window and the picture is enlarged.
  - Click “Back”  to return to the browse window.



## To increase the number of languages

Please take care that your battery is fully charged!

- 1 Make sure that your computer is connected to the Internet.
- 2 Plug the USB cable into the USB port on the computer.
- 3 Plug the other end of the USB cable into the camera's USB connector.
  - The camera turns on automatically.
  - The monitor turns on and the selection screen for the USB connection is displayed.
- 4 Select [STORAGE] and press the  button.
- 5 In the browse window, select “Camera”, then “Update Camera/Add Display Language”.
  - The confirmation window for updating is displayed.
- 6 Click “OK”.
  - The updating the camera window is displayed.
- 7 Click “Add Language” in the updating camera display.
  - The “Add Display Language of Camera” window is displayed.
- 8 Click  and select a language.
- 9 Click “Add”.
  - The new language is downloaded to your camera. Please do not remove any cable or the battery while the camera is processing.

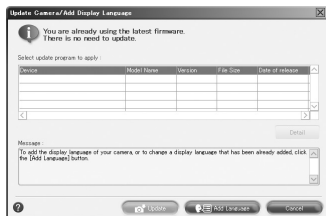

- 10** After the download procedure the camera display will show “OK”. You can remove the cables and turn power off. After restarting the camera you will be able to choose the new language from [🗨️].

## Transferring images to your computer without using OLYMPUS Master

Your camera supports the USB Mass Storage Class. You can transfer images to a computer by connecting the camera to the computer with the provided USB cable. This can be done even without using OLYMPUS Master. The following operating systems are compatible with the USB connection:

Windows : 2000 Professional/XP Home Edition/XP Professional/Vista  
Macintosh : Mac OS X v10.3 or later

### ! Notes

- If your computer is running Windows Vista, select [MTP] in Step 3 on page 108 to use Windows Photo Gallery.
- Data transfer is not guaranteed in the following environments, even if your computer is equipped with a USB port.
  - Computers with a USB port added by means of an extension card, etc.
  - Computers without a factory-installed OS and home-built computers



## Shooting tips and information

### Tips before you start taking pictures

#### The camera does not turn on even when a battery is loaded

##### The battery is not fully charged

- Charge the battery with the charger.

##### The battery is temporarily unable to function because of the cold

- Battery performance declines in low temperatures, and the charge may not be sufficient to turn on the camera. Remove the battery and warm it by putting it in your pocket for a while.

#### No picture is taken when the shutter button is pressed

##### The camera has turned off automatically

- To save battery power, if there is no operation, the camera goes into sleep mode after a fixed period of time and the camera stops operating. The camera activates again when you touch the shutter button or any other button. The camera will turn off automatically if there is no further operation for 4 hours. The camera will not work until it is turned back on.  "SLEEP" (P. 94), "4 h TIMER (Auto power off)" (P. 95)

##### The flash is charging

- When the flash is activated and the  symbol in the viewfinder is blinking, this indicates that the flash is charging. Wait for the blinking to stop, then press the shutter button.

##### Unable to focus

- When the AF confirmation mark in the viewfinder is blinking, it indicates that the camera is unable to focus using AF. Press the shutter button again.

##### Noise reduction is activated

- When shooting night scenes, shutter speeds are slower and noise tends to appear in images. The camera activates the noise-reduction process after shooting at slow shutter speeds. During which, shooting is not allowed. You can set [NOISE REDUCT.] to [OFF].  
 "Noise reduction" (P. 69)

#### The date and time has not been set

##### The camera is used with the settings at the time of purchase

- The date and time of the camera is not set when purchased. Set the date and time before using the camera.  "Setting the date/time" (P. 15)

##### The battery has been removed from the camera

- The date and time settings will be returned to the factory default settings if the camera is left without the battery for approximately 1 day. The settings will be canceled more quickly if the battery was only loaded in the camera for a short time before being removed. Before taking important pictures, check that the date and time settings are correct.

### Shooting tips

#### Focusing on the subject

There are several ways to focus, depending on the subject.

##### AF target is not focused on the subject

- Use focus lock to focus the AF target on the subject.  "Focus lock — If correct focus cannot be obtained" (P. 55)

## Other things instead of the subject are in focus on the respective AF targets

- Set [AF AREA] to [ · ] and focus on the selected AF target.  "AF target selection" (P. 53)

## The subject is moving quickly

- Focus the camera on a point roughly the same distance away as the subject you want to shoot (by pressing the shutter button halfway), and then recompose your picture and wait for the subject to enter the frame.

## Close up on the subject using macro lens

- When using macro lens to close up on the subject, it is difficult to focus with AF when the enlargement ratio of the subject is bigger. Set to manual focus (MF), rotate the focus ring and focus manually.  "MF (manual focus)" (P. 52)

## Taking pictures in low light conditions

- The built-in flash can be set to function as an AF illuminator. The flash helps to focus in low-light conditions in the AF mode when raised.  "Built-in flash shooting" (P. 73), "AF ILLUMINAT." (P. 90)

## Subjects that are difficult to focus on

It may be difficult to focus with auto focus in the following situations.

AF confirmation mark is blinking.  
These subjects are not focused.



Subject with low contrast



Excessively bright light in center of frame

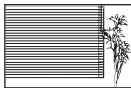

Subject with repeated patterns

AF confirmation mark lights up but the subject is not focused.



Subjects at different distances

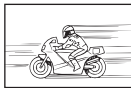

Fast-moving subject



Subject not inside AF area

In any situation, focus on something with high contrast that is at the same distance as the subject, determine the composition and shoot the picture.

## Taking pictures without blurring

There are several factors that can cause the picture to blur.

### The subject is too dark

- Change the shutter speed to match the brightness of the subject. If the shutter speed is set low to shoot a dark subject, blurring is likely to occur if the subject moves.  
Increase the value of the ISO setting. When the shutter speed is slow, camera shake becomes easier to see. Mount the camera on a tripod. Using the remote control (optional) to close the shutter is also effective for reducing blurring.

### The camera or your hand moves when pressing the shutter button

- Press the shutter button gently or hold the camera securely with both hands.
- Use the image stabilizer function.  "Image stabilizer" (P. 60)

## Taking pictures with less flash

When using auto flash, the flash will light up automatically when it is not bright enough. If the subject is too far away, the flash may have no effect. Here is how to take pictures without the flash in this type of situation.

### Setting the image stabilizer function

- This function reduces camera shake, enabling you to hold the camera and take pictures in low light situations with the flash off.  "Image stabilizer" (P. 60)

### Increase the ISO setting

- Increase the value of the ISO setting. The image may become grainy.  "ISO sensitivity setting" (P. 49)

## The picture is too grainy

There are several factors that can cause the picture to appear grainy.

### Increasing the ISO sensitivity

- When you increase the ISO setting, noise, which appears as spots of unwanted color or unevenness in the color, can be introduced and give the picture a grainy appearance. This camera is equipped with a function to allow shooting at high sensitivity while suppressing noise; however, increasing the ISO sensitivity creates grainier pictures than when using a lower sensitivity.  "ISO sensitivity setting" (P. 49)

### Image taken appears whitish

This may occur when the picture is taken in backlight or semi-backlight conditions. This is due to a phenomenon called flare or ghosting. As far as possible, consider a composition where strong light source is not taken in the picture. Flare may occur even when a light source is not present in the picture. Use a lens hood to shade the lens from the light source. If a lens hood does not have effect, use your hand to shade the lens from the light.

-  "Interchangeable lenses" (P. 126)



### Taking pictures with the correct color

The reason why there are differences between the colors in a picture and the actual colors taken and the actual color is the light source illuminating the subject. **[WB]** is the function that allows the camera to determine the correct colors. Normally, the **[AUTO]** setting provides the optimal white balance, but depending on the subject, it may be better to experiment with changing the **[WB]** setting.

- When the subject is in the shade on a sunny day
- When the subject is illuminated by both natural light and indoor lighting, such as when near a window
- When there is no white in the frame
-  "Selecting the white balance" (P. 62)



### Taking pictures of a white beach or snow scene

In normal cases, white subjects such as snow will appear darker than usual when the picture is taken. There are several ways to capture the whiteness.

- Adjust the exposure compensation toward **[+]**.  "Exposure compensation" (P. 46)
- Use **[ ]HI** (Spot metering highlight control).  
Press the shutter button halfway at the center of the viewfinder where you wish to highlight the whiteness. The metered part at the center will be set to appear whiter.  "Changing the metering mode" (P. 45)
- Use the AE bracketing function to take the picture.  
If you do not know the amount of exposure compensation, try using AE bracketing. The compensation value changes a little every time you press the shutter button. If you set a larger exposure compensation, you can change the compensation value either upwards or downwards based on that value and shoot the picture.  "AE bracketing" (P. 48)

### Taking pictures of a subject against backlight

If the background is too bright compared to the subject, the exposure will be affected at the bright parts and the subject will appear darker. This is because the camera determines the exposure from the brightness of the whole screen.

- Set **[METERING]** to **[ ]** (spot metering) to measure the exposure of the subject in the center of the picture. To change the composition, place the subject in the center of the picture. While holding down the **AEL/AFL** button, change the composition and press the shutter button.  "Changing the metering mode" (P. 45)
- Activate the flash, set the flash mode to **[ ]** (fill-in flash) and shoot the picture. You can shoot a subject against backlight without the face of the subject appearing dark. **[ ]** (fill-in flash) is used for shooting against backlight and under fluorescent and other artificial lighting.  "Flash mode setting" (P. 70)

## Image turns out too bright or too dark

When taking pictures in **S** mode or **A** mode, the displayed shutter speed or aperture setting may blink. A blinking display means that the correct exposure cannot be obtained. If you take the picture as is, the picture will appear too bright or too dark. If that happens, change the aperture setting or shutter speed.

☞ “Aperture priority shooting” (P. 41), “Shutter priority shooting” (P. 42), “Exposure warning display” (P. 129)

## Unknown bright dot(s) appear on the subject in the picture taken

This may be due to stuck pixel(s) on the image pickup device. Perform **[PIXEL MAPPING]**. If the problem persists, repeat pixel mapping a few times. ☞ “Pixel mapping — Checking the image processing functions” (P. 122)

## Additional shooting tips and information

### Increasing the number of pictures that can be taken

The captured image will be recorded on the card. The following ways describe how to record more images.

- Change the record mode.  
The size of an image varies with the record mode. When you are not sure of the available card capacity, change the image mode and shoot the picture. The smaller the image size and the higher the compression, the smaller the size of the image becomes. To make the file size small, combine the image size and compression rate and register it with **[◀: SET]**. You can further reduce the number of pixels by setting **[PIXEL COUNT]** to fewer pixels for image size **[M]** or **[S]**. ☞ “Selecting the record mode” (P. 61), “◀: SET” (P. 97), “PIXEL COUNT” (P. 98)
- Use a card with large capacity.  
The number of recordable images varies with the capacity of the card. Use a card with large capacity.

### Using a new card

If you use a non-Olympus card or a card used for another application, such as for a computer, the message **[CARD ERROR]** is displayed. To use this card with this camera, use the **[FORMAT]** function to format the card. ☞ “Formatting the card” (P. 125)

### Extending the useful life of the battery

Performing any of the following operations when not actually taking pictures can deplete the battery power.

- Repeatedly pressing the shutter button halfway
- Repeatedly playing back the captured images over a long period of time
- Using the live view function over a long period

To save battery power, turn off the camera whenever it is not in use.

### Functions that cannot be selected from menus

Some items may not be selectable from the menus when using the arrow pad.

- Items that cannot be set with the current shooting mode
- Items that cannot be set because of an item that has already been set:  
Combination of **[☺:H]** and **[NOISE REDUCT.]**, etc.

## Selecting the optimal record mode

Record modes are divided into 2 main types: RAW and JPEG. RAW records without reflecting the settings for white balance, contrast, etc. on the images themselves. JPEG records as images that reflect these settings. JPEG also compresses images to reduce the file size when recording them. For JPEG, you can register four combinations of images sizes (**L**, **M**, **S**) and compression rates (SF, F, N, B) from the 12 total combinations available. The higher the compression rate, the grainier the image will appear when enlarged during display. A rough guide for selection is shown below.

**To make fine-adjustments of the shooting settings on the computer**

- **[RAW]**

**To print large images on A3/A4 paper/To edit and process images on a computer**

- Images size **L** and compression rate SF, F, N, or B

**To print postcard-size images**

- Images size **M** and compression rate SF, F, N, or B

**To send as an e-mail attachment or post on a web site**

- Images size **S** and compression rate SF, F, N, or B

☞ "Record mode and file size/number of storable still pictures" (P. 133)

## To restore functions to their settings at the time of purchase

- The settings are saved even when the power is switched off.
- To return to the factory default settings, set **[RESET]** under **[CUSTOM RESET]**. You can register up to two types of settings to be reset. Set various functions of the camera and register using **[RESET1]** or **[RESET2]** under **[CUSTOM RESET]**. ☞ "Resetting to the factory default settings" (P. 33)

## Confirming the exposure when it is difficult to view the monitor outdoors

The monitor may be difficult to view and the exposure difficult to confirm when shooting outdoors.

During live view, press the **INFO** button repeatedly to display the histogram.

The following shows you how to read the histogram display easily.

### How to read the histogram

- ① If the graph has many peaks around here, the image will appear mostly black.
- ② If the graph has many peaks around here, the image will appear mostly white.
- ③ The part indicated in green in the histogram shows the luminance distribution within the spot metering area.

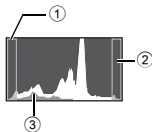

☞ "Using live view" (P. 31)

## Leaving set functions in the camera so that they can be used later

You can register up to two current camera settings in **[MY MODE SETUP]**. When shooting with My Mode, switch the shooting mode to **[M2]** or **[M2]**. By registering My Mode to the **Fn** button, you can instantly shoot with My Mode.

☞ "My Mode shooting" (P. 44), **[Fn] FUNCTION** (P. 92), "MY MODE SETUP" (P. 93)

## Playback tips

### Understanding the settings and other information of pictures taken

Play back a picture, and press the **INFO** button. Press the button repeatedly to change the amount of information displayed. ☞ "Information display" (P. 82)

## Viewing pictures on a computer

### Viewing the entire picture on a computer screen

The size of the picture displayed on a computer screen changes depending on the computer settings. When the monitor setting is 1024 × 768 and you are using Internet Explorer to view a picture with an image size of 2048 × 1536 at 100%, the entire picture cannot be viewed without scrolling. There are several ways you can view the entire picture on the computer screen.

#### View the picture using image browsing software

- Install the OLYMPUS Master software from the provided CD-ROM.











#### Change the monitor setting













- The icons on the computer desktop may be rearranged. For details of changing the settings on your computer, refer to the computer's manual.







### To view recorded images in RAW

Install the OLYMPUS Master software from the provided CD-ROM. You can use the RAW development function in OLYMPUS Master to develop the RAW image in the camera setting used during shooting, as well as change detailed settings such as white balance and contrast.

## Error codes

Viewfinder indications	Control panel indications	Monitor indications	Possible cause	Corrective action
Normal indication	- - -	 NO CARD	The card is not inserted, or it cannot be recognized.	Insert a card or insert a different card.
		 CARD ERROR	There is a problem with the card.	Insert the card again. If the problem persists, format the card. If the card cannot be formatted, it cannot be used.
		 WRITE PROTECT	Writing to the card is prohibited.	The card has been set to read-only setting with the computer. Reset the card with the computer.
		 CARD FULL	The card is full. No more pictures can be taken or no more information such as print reservation can be recorded.	Replace the card or erase unwanted pictures. Before erasing, download important images to a PC.

Viewfinder indications	Control panel indications	Monitor indications	Possible cause	Corrective action
No indication	No indication	 CARD FULL	The card has no available memory. Print reservations and new data cannot be recorded to the card.	Replace the card or erase unwanted pictures. Before erasing, download important images to a PC.
No indication	No indication		xD-Picture Cards cannot be read or is not formatted.	<ul style="list-style-type: none"> <li>Select <b>[xD CARD CLEAN]</b>, press the  button and turn off the camera. Remove the card and wipe dry the metallic surface with a soft, dry cloth.</li> <li>Select <b>[FORMAT]</b>  <b>[YES]</b>, and then press the  button to format the card. Formatting the card erases all data on the card.</li> </ul>
No indication	No indication	 NO PICTURE	There are no pictures on the card.	The card contains no pictures. Record pictures and play back.
No indication	No indication	 PICTURE ERROR	The selected picture cannot be displayed for playback due to a problem with this picture. Or the picture cannot be used for playback on this camera.	Use image processing software to view the picture on a PC. If that cannot be done, the image file is damaged.
No indication	No indication	 THE IMAGE CANNOT BE EDITED	Pictures taken with another camera cannot be edited on this camera.	Use image processing software to edit the picture.
No indication	No indication	 Internal camera temperature is too high. Please wait for cooling before camera use.	Extended use of live view or sequential shooting has increased the internal temperature of the camera.	Wait a moment for the camera to turn off automatically. Allow the internal temperature of the camera to cool before resuming operations.
		 CARD-COVER OPEN	The card cover is open.	Close the card cover.

Viewfinder indications	Control panel indications	Monitor indications	Possible cause	Corrective action
No indication	No indication	 BATTERY EMPTY	The battery is drained.	Charge the battery.
No indication	No indication	 NO CONNECTION	The camera is not connected to the computer or printer correctly.	Disconnect the camera and connect it again correctly.
No indication	No indication	 NO PAPER	There is no paper in the printer.	Load some paper in the printer.
No indication	No indication	 NO INK	The printer has run out of ink.	Replace the ink cartridge in the printer.
No indication	No indication	 JAMMED	The paper is jammed.	Remove the jammed paper.
No indication	No indication	SETTINGS CHANGED	The printer's paper cassette has been removed or the printer has been manipulated while making settings on the camera.	Do not manipulate the printer while making settings on the camera.
No indication	No indication	 PRINT ERROR	There is a problem with the printer and/or camera.	Turn off camera and printer. Check the printer and remedy any problems before turning the power on again.
No indication	No indication	 CANNOT PRINT	Pictures recorded on other cameras may not be printed on this camera.	Use a personal computer to print.



## Cleaning and storing the camera

### Cleaning the camera

Turn off the camera and remove the battery before cleaning the camera.

#### **Exterior:**

- Wipe gently with a soft cloth. If the camera is very dirty, soak the cloth in mild soapy water and wring well. Wipe the camera with the damp cloth and then dry it with a dry cloth. If you have used the camera at the beach, use a cloth soaked in clean water and well wrung.

#### **Monitor and viewfinder:**

- Wipe gently with a soft cloth.

#### **Lens, mirror and focusing screen:**

- Blow dust off the lens, mirror and focusing screen with a commercially available blower. For the lens, wipe gently with a lens cleaning paper.

### Storage

- When not using the camera for a prolonged period, remove the battery and card. Store the camera in a cool, dry place that is well ventilated.
- Insert the battery periodically and test the camera's functions.

### Cleaning and checking the image pickup device

This camera incorporates a dust reduction function to keep dust from getting on the image pickup device and to remove any dust or dirt from the image pickup device surface with ultrasonic vibrations. Dust reduction is activated when the power switch is set to ON and when starting and stopping live view. The dust reduction function operates at the same time as the pixel mapping, which checks the image pickup device and image processing circuitry. Since dust reduction is activated every time the camera's power is turned on, the camera should be held upright for the dust reduction function to be effective. The SSWF indicator blinks while dust reduction is working.  "SSWF indicator" (P. 14)

#### **!** Notes



- Do not use strong solvents such as benzene or alcohol, or a chemically treated cloth.
- Avoid storing the camera in places where chemicals are treated, in order to protect the camera from corrosion.
- Mold may form on the lens surface if the lens is left dirty.
- Check each part of the camera before use if it has not been used for a long time. Before taking important pictures, be sure to take a test shot and check that the camera works properly.

## Cleaning mode — Removing dust

If dust or dirt gets on the image pickup device, black dots may appear in the picture. Contact your Olympus Authorized Service Center to have the image pickup device physically cleaned. The image pickup device is a precision device and is easily damaged. When cleaning the image pickup device yourself, be sure to follow the instructions below. If power runs out during cleaning, the shutter will close, which may cause the shutter curtain and mirror to break. Keep an eye on the remaining battery power.

**1** Remove the lens from the camera, and set the power switch to ON.

**2** MENU ▸ [i1] ▸ [i2] ▸ [CLEANING MODE]

**3** Press , then press the  button.

- The camera enters the cleaning mode.

**4** Press the shutter button all the way.

- The mirror goes up and the shutter curtain opens.

**5** Clean the image pickup device.

- Carefully blow off any dust on the surface of the image pickup device by using a mechanical blower (commercially available).

**6** Be careful not to catch the mechanical blower in the shutter curtain when turning the power off to finish cleaning.

- If the camera turns off, the shutter curtain closes, causing the mirror to fall.

### Notes

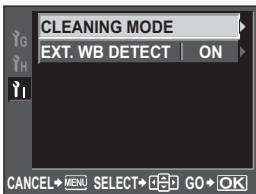

- Be careful not to let the mechanical blower (commercially available) touch the image pickup device. If the blower touches the image pickup device, the image pickup device will be damaged.
- Never put the mechanical blower behind the lens mount. If the power turns off, the shutter closes, breaking the shutter curtain.
- Do not use anything other than the mechanical blower. If high-pressure gas is sprayed onto the image pickup device, it will freeze on the image pickup device's surface, damaging the image pickup device.



## Pixel mapping — Checking the image processing functions

The pixel mapping feature allows the camera to check and adjust the image pickup device and image processing functions. After using the monitor or taking continuous shots, wait for at least one minute before using the pixel mapping function to ensure that it operates correctly.

**1** MENU ▸ [i2] ▸ [PIXEL MAPPING]

**2** Press , then press the  button.

- The [BUSY] bar is displayed when pixel mapping is in progress. When pixel mapping is finished, the menu is restored.

### Notes

- If you accidentally turn the camera off during pixel mapping, start again from Step 1.

## Main optional accessories

You can use the following Olympus accessories with this camera.

### Power supply

#### HLD-4 Power battery holder

Attach the power battery holder and use it as a grip for taking pictures with the camera held vertically. It enables you to use the camera for a long period of time.

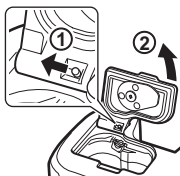

To attach the power battery holder to the camera, remove the camera's battery cover, as shown in the diagram to the left.

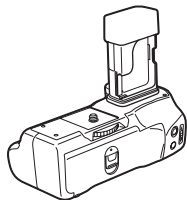

#### BCM-1 Li-ion battery charger

This charger is for charging the BLM-1 lithium ion battery included with this camera. It takes about 2 hours to charge the battery with this charger.

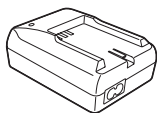

### Wireless flashes

#### FL-50R/FL-36R Olympus wireless RC flash system

These external flashes emit a large amount of light and can be used for FP flash and multiple wireless flash shooting.

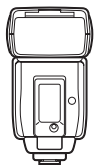

### Remote cable

#### RM-CB1 Remote cable

This remote switch is effective for macro and bulb shooting. Connect it to the remote cable connector on the camera.



## Eyecups

### DE-P3/DE-N3 Diopter compensation eyecups

These eyecups enable users to shoot without having to wear their eyeglasses regardless of whether the user is nearsighted or farsighted.

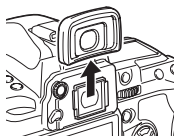

To remove the optional eyecup, remove it as shown on the left.

## Card basics

### Usable cards

“Card” in this manual refers to a recording medium. This camera can use CompactFlash, Microdrive or xD-Picture Card (optional).

#### CompactFlash

A CompactFlash is a large-capacity solid state flash memory card. You can use commercially available cards.

#### Microdrive

A Microdrive is a medium that uses a large-capacity compact hard disk drive. You can use a Microdrive that supports CF+Type II (CompactFlash extension standard).

#### xD-Picture Card

An xD-Picture Card is a recording medium used mainly in compact cameras.

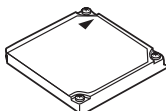
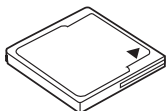

### Precautions when using a Microdrive

A Microdrive is a medium that uses a compact hard disk drive. Because the disk drive rotates, a Microdrive is not as resistant to vibration or impact as other cards. Special care is needed when using a Microdrive (especially during recording and playback) to make sure the camera is not subjected to shock or vibrations. Be sure to read the following precautions before using a Microdrive.

Also, refer to the manuals provided with your Microdrive.

- Be very careful when putting the camera down during recording. Place it gently on a firm surface.
- Do not use the camera in places subject to vibrations or excessive shock, such as at a construction site or in a car while driving along a bumpy road.
- Do not take a Microdrive close to areas where it may be exposed to strong magnetism.

#### Notes

- The data in the card will not be erased completely even after formatting the card or deleting the data. When discarding, destroy the card to prevent leakage of personal information.

## Formatting the card

Non-Olympus cards or cards formatted on a computer must be formatted with the camera before they can be used.  
All data stored on the card, including protected images, is erased when the card is formatted. When formatting a used card, confirm there are no images that you still want to keep on the card.

- 1 MENU**  $\blacktriangleright$  **[M]**  $\blacktriangleright$  **[CARD SETUP]**
- 2** Use  $\leftarrow$   $\rightarrow$  to select **[FORMAT]**, then press the **[OK]** button.
- 3** Use  $\leftarrow$   $\rightarrow$  to select **[YES]**, then press the **[OK]** button.
  - Formatting is performed.

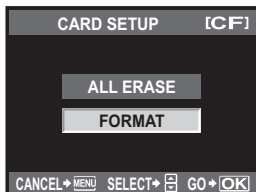

### TIPS

**When inserting cards into the two card slots:**

→ Select the card to be used in **[CF/xD]**.  $\leftarrow$  "CF/xD" (P. 99)

## Battery and charger

- Use the single Olympus lithium-ion battery (BLM-1). Other batteries cannot be used.
- The camera's power consumption varies widely with usage and other conditions.
- As the following consume a lot of power even without shooting, the battery will be drained quickly.
  - Performing auto focus repeatedly by pressing the shutter button halfway in shooting mode.
  - Using live view.
  - Displaying images on the LCD monitor for a prolonged period.
  - When connected to a computer or printer.
- When using a drained battery, the camera may turn off without the low battery warning being displayed.
- The battery will not be fully charged at the time of purchase. Charge the battery using the designated charger (BCM-2) before use.
- The normal charging time of the provided rechargeable battery is approximately 5 hours (estimated).
- Do not use chargers other than the one designated.

## AC adapter

It is recommended to use the AC-1 AC adapter (optional) for prolonged slideshows, transferring pictures to a computer, or other operations that may take a long time to perform. Do not use other AC adapters.

- ! Notes**
  - Do not remove the battery or unplug the AC adapter when the camera is on or is connected to another device. This can affect the camera settings and functions.
  - Refer to the manual provided with the AC adapter.

## Using your charger abroad

- The charger and AC adapter can be used in most home electrical sources within the range of 100 V to 240 V AC (50/60Hz) around the world. However, depending on the country or area you are in, the AC wall outlet may be shaped differently and the charger may require a plug adapter to match the wall outlet. For details, ask at your local electrical shop or travel agent.
- Do not use commercially available travel adaptors as the charger or AC adapter may malfunction.

## Interchangeable lenses

Select the lens that you want to shoot with.

Use a specified Four Thirds lens (Four Thirds mount). When a non-specified lens is used, auto focus and light metering will not function correctly. In some cases, other functions may not work either.

### Four Thirds mount

Developed by Olympus as the lens mount standard for the Four Thirds system. These all-new interchangeable lenses featuring the Four Thirds mount were developed from the ground up based on optic engineering exclusively for digital cameras.

## ZUIKO DIGITAL interchangeable lens

Four Thirds system interchangeable lens are designed to withstand rigorous professional use. The Four Thirds system makes it possible for a fast lens to be compact and lightweight as well.

### Focal distance and depth of field of Four Thirds system lenses

When compared to 35-mm cameras, Four Thirds system cameras achieve different effects at the same focal distance and aperture.

#### Focal distance

At the same focal distance of a 35-mm camera, a Four Thirds system camera can achieve a focal distance equivalent to twice that of a 35-mm camera. This enables the design of compact telephoto lenses. A 14-50 mm Four Thirds system lens, for example, is equivalent to a 28-100 mm lens for a 35-mm camera.

- When the image angle of Four Thirds system lens is converted to that of a 35-mm camera, the perspective is the same as that of a 35-mm camera.

#### Depth of Field

A Four Thirds system camera can achieve a depth of field equivalent to two times deeper than that of a 35-mm camera. This enables more light to enter through the aperture. A Four Thirds system lens with f2.0 brightness, for example, is equivalent to f4.0 when converted to the aperture of a 35-mm camera.

- You can achieve the same amount of background blur as if you were using a 35-mm camera.

### Notes

- When you attach or remove the body cap and lens from the camera, keep the lens mount on the camera pointed downward. This helps prevent dust and other foreign matter from getting inside the camera.
- Do not remove the body cap or attach the lens in dusty places.
- Do not point the lens attached to the camera toward the sun. This may cause the camera to malfunction or even ignite due to the magnifying effect of sunlight focusing through the lens.
- Be careful not to lose the body cap and rear cap.
- Attach the body cap to the camera to prevent dust from getting inside when no lens is attached.

## ZUIKO DIGITAL lens specifications

### Names of parts

- ① Hood mount section
- ② Filter mount thread
- ③ Zoom ring
- ④ Focus ring
- ⑤ Mount index
- ⑥ Electrical contacts
- ⑦ Front cap
- ⑧ Rear cap
- ⑨ Lens hood

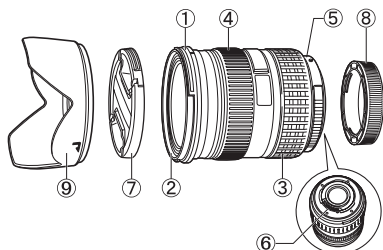

### Attaching the hood

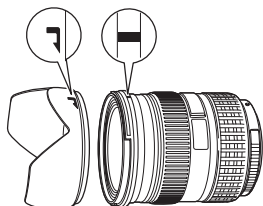

### Storing the hood

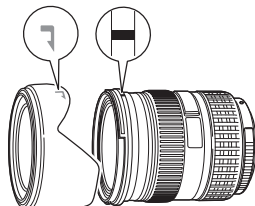

- Use the hood when shooting a backlit subject.

### Main Specifications

Items	12 - 60 mm	50 - 200 mm
Mount	FOUR THIRDS mount	
Focal distance	12 - 60 mm	50 - 200 mm
Max. aperture	f2.8 - 4.0	f2.8 - 3.5
Image angle	84° - 20°	24° - 6.2°
Lens configuration	10 groups, 14 lenses	15 groups, 16 lenses
	Multilayer film coating (partially single layered)	
Iris control	f2.8 - 22	f2.8 - 22
Shooting range	0.25 m - ∞	1.2 m - ∞
Focus adjustment	AF/MF switching	
Weight (excluding hood and cap)	575 g	995 g
Dimensions (Max. diameter × overall length)	ø79.5 × 98.5 mm	ø86.5 × 157 mm
Lens hood mount	Bayonet	
Filter mount thread diameter	72 mm	67 mm

Can be used with the optional EX-25 extension tube under the following conditions.  
The focus adjustment when EX-25 is used will be MF.

Lens, focal distance		Shooting range	Magnification ( ): Calculated based on 35 mm film camera
12-60 mm	12 mm	Shooting is not possible since subjects cannot be brought into focus at this focal length.	
	60 mm	21.0 cm - 25.5 cm	0.43 - 0.58× (0.86 - 1.16×)
50-200 mm		Can be shot in the whole zoom range	0.12 - 0.49× (0.24 - 0.98×)

### ■ Storage Precautions

- Clean the lens after use. Remove dust and dirt on the surface of the lens with a blower brush or brush. Use commercially available lens cleaning paper to remove the dirt on the lens. Do not use organic solvents.
- Always cap the lens and store it when it is not used.
- Do not store in an area with insect repellent.

### ❗ Notes on Shooting

- Edges of pictures may be cut off if more than one filter is used or if a thick filter is used.

## Program line diagram (P mode)

In the **P** mode, the camera is programmed such that the aperture value and shutter speed are automatically selected according to the subject's brightness as shown below. The program line diagram varies with the type of lens mounted.

— When using the  
14 - 54 mm f2.8 - 3.5  
zoom lens  
(focal length: 14 mm,  
ISO100)

— Program shift

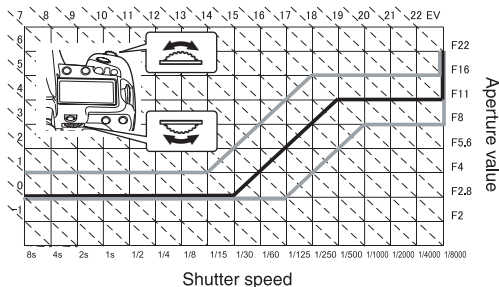



## Flash synchronization and shutter speed

Shooting mode	Shutter speed	Flash timing	Upper limit of synchronization timing <sup>*1</sup>	Fixed timing when flash fires <sup>*2</sup>
<b>P</b>	60 - 1/8000 sec.	1/ (lens focal length × 2) or synchronization timing, whichever is slower	1/250	1/60
<b>A</b>	60 - 1/8000 sec.	1/ (lens focal length × 2) or synchronization timing, whichever is slower	1/250	1/60
<b>S</b>	60 - 1/8000 sec.	The set shutter speed	1/250	—
<b>M</b>	60 - 1/8000 sec.	The set shutter speed	1/250	—

\*1 Can be changed using menu: 1/60 - 1/250 "X-SYNC." (P. 96)

\*2 Can be changed using menu: 1/30 - 1/250 "SLOW LIMIT" (P. 96)

## Exposure warning display

If the optimum exposure cannot be obtained when pressing the shutter button halfway, the display will blink in the viewfinder and on the control panel.

Shooting mode	Warning display example (blinking)	Status	Action
<b>P</b>		The subject is too dark.	<ul style="list-style-type: none"> <li>• Increase the ISO sensitivity.</li> <li>• Use the flash.</li> </ul>
		The subject is too bright.	<ul style="list-style-type: none"> <li>• Decrease the ISO sensitivity.</li> <li>• Use a commercially available ND filter (for adjusting the amount of light).</li> </ul>
<b>A</b>		The subject is underexposed.	<ul style="list-style-type: none"> <li>• Decrease the aperture value.</li> <li>• Increase the ISO sensitivity.</li> </ul>
		The subject is overexposed.	<ul style="list-style-type: none"> <li>• Increase the aperture value.</li> <li>• Decrease the ISO sensitivity or use a commercially available ND filter (for adjusting the amount of light).</li> </ul>
<b>S</b>		The subject is underexposed.	<ul style="list-style-type: none"> <li>• Set the shutter speed slower.</li> <li>• Increase the ISO sensitivity.</li> </ul>
		The subject is overexposed.	<ul style="list-style-type: none"> <li>• Set the shutter speed faster.</li> <li>• Decrease the ISO sensitivity or use a commercially available ND filter (for adjusting the amount of light).</li> </ul>

\* The aperture value at the moment when its indication blinks varies with the lens type and focal length of the lens.

## Flash distance

The flash distances when shooting with the built-in flash according to the ISO sensitivity/aperture value settings are as follows.

	ISO sensitivity						Flash distance (m)
	3200	1600	800	400	200	100	
Aperture value	f8	f5.6	f4	f2.8	f2	f1.4	9.3
	f11	f8	f5.6	f4	f2.8	f2	6.5
	f16	f11	f8	f5.6	f4	f2.8	4.6
	f22	f16	f11	f8	f5.6	f4	3.3
	f32	f22	f16	f11	f8	f5.6	2.3
		f32	f22	f16	f11	f8	1.6
			f32	f22	f16	f11	1.2
				f32	f22	f16	0.8
					f32	f22	0.6







































## Vignetting of the built-in flash when using an interchangeable lens

Lenses in the range of 14 mm to 150 mm can be used with the built-in flash. The following lenses, however, may interfere with the light emitted by the built-in flash and, therefore, may limit the focal distance and shooting range.

Lens	Focal distance	Shooting range
ED14 - 42 mm f3.5 - 5.6	14 mm	1.2 m or more
ED14 - 45 mm f3.5 - 5.6	14 mm	1.2 m or more
ED14 - 54 mm f2.8 - 3.5	14 mm	1.2 m or more
ED12 - 60 mm f2.8 - 4.0 SWD	14 mm	2.0 m or more

- The shooting ranges above are for when the lens hood is not mounted.
- The flash control may not function properly when macro shooting with the built-in flash at a range closer than 0.5 m (1.6 ft).

## Flash modes that can be set by shooting mode

Shooting mode	Viewfinder indications	Control panel indications	Super control panel indications	Flash mode	Flash timing	Conditions for firing the flash	Shutter speed limit
P A  	 -R	 -A	 <b>AUTO</b>	Auto flash	1st curtain	Fires automatically in dark/backlit* conditions	1/30 sec. - 1/250 sec.
	 00 -R	 -A 		Auto flash (red-eye reduction)			
				Fill-in flash		Always fires	
	 OFF	 OFF		Flash off	—	—	—
	 SLo 00 -R	 SLOW 	 <b>SLOW</b>	Slow synchronization (red-eye reduction)	1st curtain	Fires automatically in dark/backlit* conditions	60 sec. - 1/250 sec.
	 SLo -R	 SLOW	 <b>SLOW</b>	Slow synchronization			
	 SLo 2 -R	 SLOW 	 <b>SLOW2</b>	Slow synchronization	2nd curtain		
	 FULL	 FULL	 <b>FULL</b>	Manual flash (FULL)	1st curtain	Always fires	
	 1-4	 1-4	 <b>1/4</b>	Manual flash (1/4)			
	 1-16	 1-16	 <b>1/16</b>	Manual flash (1/16)			
 1-64	 1-64	 <b>1/64</b>	Manual flash (1/64)				

\* When the flash is set to the Super FP mode, it detects backlight with longer duration than for normal flash before firing.  "Super FP flash" (P. 76)

Shooting mode	Viewfinder indications	Control panel indications	Super control panel indications	Flash mode	Flash timing	Conditions for firing the flash	Shutter speed limit
S M B	⚡	⚡	⚡	Fill-in flash	1st curtain	Always fires	60 sec. - 1/250 sec.
	⚡ □□	⚡ ⊙	👁️ ⚡	Fill-in flash (red-eye reduction)			
	⚡ □FF	⚡ □FF	⊕	Flash off	—	—	—
	⚡ 2	⚡ 2nd-CURTAIN	2nd CURTAIN	Fill-in flash/ Slow synchronization	2nd curtain	Always fires	60 sec. - 1/250 sec.
	⚡ FULL	⚡ FULL	⚡ FULL	Manual flash (FULL)	1st curtain		
	⚡ 1-4	⚡ 1-4	⚡ 1/4	Manual flash (1/4)			
	⚡ 1-16	⚡ 1-16	⚡ 1/16	Manual flash (1/16)			
	⚡ 1-64	⚡ 1-64	⚡ 1/64	Manual flash (1/64)			

## White balance color temperature

The higher the color temperature, the richer the light in bluish tones and the poorer in reddish; the lower the color temperature, the richer the light in reddish tones and the poorer in bluish. The spectral balance of different white light sources is rated numerically by color temperature — concept of physics expressed using the Kelvin (K) temperature scale. The color of sunlight and other natural light sources and the color of a light bulb and other artificial light sources can be expressed in terms of color temperature.

It follows, then, that the color temperatures of fluorescent lights make them unsuitable as artificial light sources. There are gaps in the hues from the color temperatures of fluorescent light. If these differences in hue are small, they can be calculated with color temperature and this is called correlated color temperature.

The 4000K, 4500K and 6600K preset settings in this camera are correlated color temperatures, and should not be considered strictly as color temperatures. Use these settings for shooting conditions under fluorescent lights.

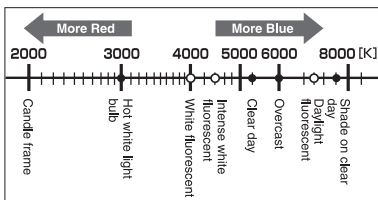

- The color temperatures for each light source indicated in the above scale are approximate.

## Record mode and file size/number of storable still pictures

The file size in the table is approximate.

Record mode	Number of pixels (PIXEL COUNT)	Compression	File format	File size (MB)	Number of storable still pictures (with 1GB xD-Picture Card)
RAW	3648 × 2736	Loss-less compression	ORF	Approx. 11	91
SF		1/2.7		Approx. 6.8	147
F		1/4		Approx. 4.7	211
N		1/8		Approx. 2.2	460
B		1/12		Approx. 1.5	687
SF	3200 × 2400	1/2.7	JPEG	Approx. 5.3	187
F		1/4		Approx. 3.7	267
N		1/8		Approx. 1.7	597
B		1/12		Approx. 1.1	888
SF	2560 × 1920	1/2.7		Approx. 3.6	280
F		1/4		Approx. 2.2	466
N		1/8		Approx. 1.1	927
B		1/12		Approx. 0.7	1361
SF	1600 × 1200	1/2.7		Approx. 1.3	799
F		1/4		Approx. 0.8	1163
N		1/8		Approx. 0.5	2284
B		1/12		Approx. 0.3	3198
SF	1280 × 960	1/2.7		Approx. 0.8	1230
F		1/4		Approx. 0.5	1776
N		1/8		Approx. 0.3	3366
B		1/12		Approx. 0.2	4920
SF	1024 × 768	1/2.7		Approx. 0.5	1881
F		1/4		Approx. 0.4	2665
N		1/8		Approx. 0.2	4920
B		1/12		Approx. 0.1	7107
SF	640 × 480	1/2.7	Approx. 0.2	4569	
F		1/4	Approx. 0.2	6396	
N		1/8	Approx. 0.1	10661	
B		1/12	Approx. 0.1	12793	

### Notes

- The number of remaining pictures may change according to the subject or factors like whether print reservations have been made or not. In certain instances, the number of remaining pictures displayed on the viewfinder or the LCD monitor does not change even when you take pictures or stored images are erased.
- The actual file size varies according to the subject.

## Functions that can be registered with My Mode and Custom Reset Setting

























Function	My Mode registration	Custom reset setting registration	Function	My Mode registration	Custom reset setting registration
Shooting mode	✓	—	L fps	—	✓
	✓	✓	SLEEP	—	✓
Image stabilizer	—	✓	BACKLIT LCD	—	✓
	✓	✓	4 h TIMER	—	—
AF MODE	✓	✓	USB MODE	—	—
AF AREA	✓	✓	LIVE VIEW BOOST	✓	✓
AE BKT	✓	✓	FRAME ASSIST	✓	✓
ISO BKT	✓	✓	EV STEP	—	✓
WB BKT	✓	✓	ISO STEP	—	✓
FL BKT	✓	✓	ISO-AUTO SET	—	✓
PICTURE MODE	✓	✓	ISO-AUTO	—	✓
GRADATION	✓	✓	AELMetering	—	✓
	✓	✓	BULB TIMER	—	✓
NOISE REDUCT.	✓	✓	X-SYNC.	✓	✓
WB	✓	✓	SLOW LIMIT	✓	✓
	✓	✓		—	✓
METERING	✓	✓	ALL	—	—
ISO	✓	✓	COLOR SPACE	✓	✓
NOISE FILTER	✓	✓	SHADING COMP.	✓	✓
Flash mode	✓	✓		—	✓
RC MODE	✓	✓		—	✓
	✓	✓	QUICK ERASE	—	✓
AF ILLUMINAT.	✓	✓	RAW+JPEG ERASE	—	✓
FOCUS RING	—	✓	FILE NAME	—	—
C-AF LOCK	—	—	PRIORITY SET	—	—
AF AREA POINTER	—	—	dpi SETTING	—	—
AF SENSITIVITY	—	—	CLEANING MODE	—	—
SET UP	—	—	EXT. WB DETECT	✓	✓
RESET LENS	—	—		—	—
BULB FOCUSING	—	—	EDIT FILENAME	—	—
DIAL	—	✓		—	—
AEL/AFL	—	✓		—	✓
AEL/AFL MEMO	—	✓	PIXEL MAPPING	—	—
FUNCTION	—	✓	FIRMWARE	—	—
MY MODE SETUP	—	—			
BUTTON TIMER	—	—			
	—	✓			
RLS PRIORITY S	✓	✓			
RLS PRIORITY C	✓	✓			

✓: Can be registered. —: Cannot be registered.

\* Includes anti-shock.

# Menu directory

## Shooting Menu

Tab	Function	Setting	Ref. page	
	CARD SETUP	ALL ERASE/FORMAT	P. 89 P. 125	
	CUSTOM RESET	RESET		P. 33
		RESET1	SET/RESET	
		RESET2	SET/RESET	
	PICTURE MODE	$\uparrow$ VIVID/ $\downarrow$ NATURAL/ $\frac{1}{3}$ MUTED/ $\uparrow$ PORTRAIT/ MONOTONE/CUSTOM		P. 67
	GRADATION	AUTO/NORMAL*/HIGH KEY/LOW KEY		P. 68
		RAW/ $\frac{1}{2}$ F/ $\frac{1}{2}$ N*/ $\frac{1}{2}$ M/ $\frac{1}{2}$ S/N/RAW+ $\frac{1}{2}$ F/RAW+ $\frac{1}{2}$ N/RAW+ $\frac{1}{2}$ M/ RAW+ $\frac{1}{2}$ S/N		P. 61
	WB	AUTO*	A -7 - +7, G -7 - +7	P. 62
		 5300K	A -7 - +7, G -7 - +7	
		 7500K	A -7 - +7, G -7 - +7	
		 6000K	A -7 - +7, G -7 - +7	
		 3000K	A -7 - +7, G -7 - +7	
		 4000K	A -7 - +7, G -7 - +7	
		 4500K	A -7 - +7, G -7 - +7	
 6600K		A -7 - +7, G -7 - +7		
 5500K		A -7 - +7, G -7 - +7		
 1 - 4		A -7 - +7, G -7 - +7		
	CWB	2000K - 14000K		
ISO	AUTO*/100 - 3200		P. 49	
NOISE REDUCT.	OFF/ON*		P. 69	
NOISE FILTER	OFF/LOW/STANDARD*/HIGH		P. 69	
	METERING	 ESP + AF*/ESP	P. 45	
				
		 HI		
		 SH		
				
	 RC MODE	OFF*/ON		P. 76
		-3.0 - 0.0* - +3.0		P. 73
	AF MODE	S-AF*/C-AF/MF/S-AF+MF/C-AF+MF		P. 51
	AF AREA	 /  /  / 		P. 53
	ANTI-SHOCK[  ]	OFF*/1SEC - 30SEC		P. 59
	AE BKT	OFF*/ $\frac{1}{3}$ F 0.3EV/ $\frac{1}{3}$ F 0.7EV/ $\frac{1}{3}$ F 1.0EV/ $\frac{1}{5}$ F 0.3EV/ $\frac{1}{5}$ F 0.7EV/ $\frac{1}{5}$ F 1.0EV		P. 48
	WB BKT	A-B	OFF*/ $\frac{1}{3}$ F 2STEP/ $\frac{1}{3}$ F 4STEP/ $\frac{1}{3}$ F 6STEP	P. 66
		G-M		
	FL BKT	OFF*/ $\frac{1}{3}$ F 0.3EV/ $\frac{1}{3}$ F 0.7EV/ $\frac{1}{3}$ F 1.0EV		P. 74
ISO BKT	OFF*/ $\frac{1}{3}$ F 0.3EV/ $\frac{1}{3}$ F 0.7EV/ $\frac{1}{3}$ F 1.0EV		P. 50	

\* Factory default setting

## Playback Menu

Tab	Function	Setting	Ref. page	
▶		/4//16/	P. 83	
		OFF/ON*	P. 83	
	EDIT	RAW DATA EDIT		P. 84
		JPEG EDIT	/SHADOW ADJ	
			P. 101	
	COPY ALL	YES/NO	P. 86	
	RESET PROTECT	YES/NO	P. 87	

\* Factory default setting

## Custom Menu 1





Tab	Function	Setting	Ref. page		
11		AF/MF	P. 90		
		AF ILLUMINAT.	OFF/ON*	P. 90	
		FOCUS RING		P. 90	
		C-AF LOCK	OFF/ON	P. 90	
		AF AREA POINTER	OFF/ON*	P. 90	
		AF SENSITIVITY	NORMAL*/SMALL	P. 90	
		[] SET UP	OFF*/LOOP/SPIRAL	P. 91	
		RESET LENS	OFF/ON*	P. 91	
		BULB FOCUSING	OFF/ON*	P. 91	
		BUTTON/DIAL	P. 91		
	DIAL	<b>P</b>	<b>Ps</b> *//1/2	P. 91	
			<b>A</b>		FNo.*//1/2
			<b>S</b>		SHUTTER*//1/2
			<b>M</b>		Main dial: SHUTTER*/FNo.* Sub dial: SHUTTER*/FNo.
			<b>MENU</b>		Main dial: /↑/↓/VALUE* Sub dial: /↑/↓/VALUE
	AEL/AFL	S-AF*	mode1*/mode2/mode3	P. 92	
		C-AF	mode1/mode2*/mode3/mode4		
		MF	mode1*/mode2/mode3		
	AEL/AFL MEMO	OFF*/ON	P. 92		
FUNCTION	PREVIEW*/LIVE PREVIEW//[] HOME/MF/ RAW /P/A/S/M/TEST PICTURE/MY MODE//1/2/ OFF	P. 92			
MY MODE SETUP	MY MODE1/ MY MODE2	P. 93			
BUTTON TIMER	OFF*/3SEC/5SEC/8SEC/HOLD	P. 94			
	OFF*/ON	P. 94			



Tab	Function	Setting	Ref. page	
11	RELEASE/		P. 94	
	RLS PRIORITY S	OFF*/ON	P. 94	
	RLS PRIORITY C	OFF*/ON*	P. 94	
	Lfps	1fps/2fps/3fps*/4fps	P. 94	
	DISP/		P. 94	
		OFF*/ON*	P. 94	
	SLEEP	OFF/1MIN*/3MIN/5MIN/10MIN	P. 94	
	BACKLIT LCD	8SEC*/30SEC/1MIN/HOLD	P. 95	
	4 h TIMER	OFF/4 h*	P. 95	
	USB MODE	AUTO*/STORAGE/MTP/CONTROL/EASY/ CUSTOM	P. 95	
LIVE VIEW BOOST	OFF*/ON	P. 95		
FRAME ASSIST	OFF*/GRID/GOLDEN SECTION/SCALE	P. 95		
12	EXP//ISO		P. 96	
	EV STEP	1/3EV*/1/2EV/1EV	P. 96	
	ISO STEP	1/3EV*/1EV	P. 96	
	ISO-AUTO SET	HIGH LIMIT	100 - 3200 (800*)	P. 96
		DEFAULT	100 - 3200 (100*)	
	ISO-AUTO	P/A/S*/ALL	P. 96	
	AEL Metering	AUTO*// / / HI/ SH	P. 96	
BULB TIMER	—	P. 96		
13	CUSTOM		P. 96	
	X-SYNC.	1/60 - 1/250*	P. 96	
	SLOW LIMIT	1/30 - 1/250 (1/60*)	P. 96	
	+	OFF*/ON	P. 96	
14	/COLOR/WB		P. 97	
	ALL	ALL SET	A -7 - +7 G -7 - +7	P. 97
		ALL RESET	YES/NO	
	COLOR SPACE	sRGB*/AdobeRGB	P. 97	
	SHADING COMP.	OFF*/ON	P. 97	
	SET	1 -  4	/ /  SF/F/N/B	P. 97
	PIXEL COUNT	Middle	3200 × 2400/2560 × 1920*/ 1600 × 1200	P. 98
		Small	1280 × 960*/1024 × 768/640 × 480	
15	RECORD/ERASE		P. 98	
	QUICK ERASE	OFF*/ON	P. 98	
	RAW+JPEG ERASE	JPEG/RAW/RAW+JPEG*	P. 98	
	FILE NAME	AUTO*/RESET	P. 98	
	PRIORITY SET	NO*/YES	P. 99	
	dpi SETTING	AUTO*/CUSTOM	P. 99	
16	UTILITY		P. 99	
	CLEANING MODE	—	P. 122	
	EXT. WB DETECT	OFF*/ON*	P. 99	

\* Factory default setting

## Custom Menu 2

Tab	Function	Setting	Ref. page	
12		—	P. 15	
	CF/xD	CF*/xD	P. 99	
	EDIT FILENAME	Adobe RGB sRGB	OFF*/A-Z/0-9	P. 99
		AUTO*/-7 - +7	P. 99	
		*1	P. 100	
	VIDEO OUT	*1	P. 100	
	REC VIEW	OFF/AUTO  /1SEC - 20SEC (5 SEC*)	P. 100	
	PIXEL MAPPING	—	P. 122	
	FIRMWARE	—	P. 100	

\* Factory default setting

\*1 Settings differ depending on the region where the camera is purchased.

### **A (Aperture Priority) Mode**

You set the aperture yourself and the camera automatically varies the shutter speed so that the picture is taken with the correct exposure.

### **AE (Automatic Exposure)**

The camera's built-in exposure meter automatically sets the exposure. The 3 AE modes available on this camera are **P** mode, in which the camera selects both the aperture and shutter speed, **A** mode, in which the user selects the aperture and the camera sets the shutter speed, and **S** mode, in which the user selects the shutter speed and the camera sets the aperture. In **M** mode, the user selects both the aperture and the shutter speed.

### **Aperture**

The adjustable lens opening which controls the amount of light that enters the camera. The larger the aperture, the shorter the depth of field and the fuzzier the background. The smaller the aperture, the greater the depth of field and the sharper the background. Aperture is measured in f/stops. Larger aperture values indicate smaller apertures, and smaller aperture values indicate larger apertures.

### **Center weighted averaging metering**

A light metering mode or technique that uses an average of the center and periphery of the image area but is biased toward the information at the center of the image area. This method is best used when the brightness of the center and periphery of the image area does not vary greatly. See also digital ESP metering and spot metering.

### **Color space**

A model that describes colors using more than three coordinates. Color spaces such as sRGB, Adobe RGB are occasionally used for encoding/reproducing colors.

### **Color temperature**

The spectral balance of different white light sources is rated numerically by color temperature - a concept of theoretical physics that, with incandescent lighting, corresponds roughly to the absolute lamp filament temperature, expressed on the Kelvin (K) temperature scale. The higher the color temperature, the richer the light in bluish tones and the poorer in reddish; the lower the color temperature, the richer the light in reddish tones and the poorer in bluish. You may encounter difficulties with color reproduction when shooting indoors under fluorescent lighting, or where sunlight and fluorescent lighting are both present. Your camera is provided with a white balance adjustment feature that you can use to compensate for the odd effects of combinations of color you may occasionally see in your pictures.

### **Compression rate**

Compression is a method of reducing file size by abbreviating some contents of data, and compression rate denotes the amount of compression. The actual effect of the selected compression rate could vary with the content of the image. The numbers for the compression rate selected with this camera provide only a general scale for reference and are not precise measurements.

### **DCF (Design rule for Camera File system)**

A standard for image files by the Japan Electronics and Information Technology Industries Association (JEITA).

### **Depth of Field**

Depth of Field refers to the distance from the nearest to the furthest point of perceived "sharp" focus in a picture.

### **Digital ESP (Electro-Selective Pattern) Light Metering**

This determines the exposure by splitting the image into 49 areas and metering and calculating the light levels in each area.

### **DPOF (Digital Print Order Format)**

This is for saving desired print settings on digital cameras. By entering which images to print and the number of copies of each, the user can easily have the desired images printed by a printer or print lab that supports the DPOF format.

**Eclipsing (Vignetting)**

This refers to when an object obscures part of the field of view so that the whole subject is not photographed. Vignetting also refers to when the image seen through the viewfinder does not exactly match the image shot through the objective lens, so the photographed image includes objects not seen through the viewfinder. In addition, vignetting can occur when an incorrect lens hood is used, causing shadowing to appear in the corners of the image.

**EV (Exposure Value)**

A system for measuring exposure. EV0 is when the aperture is at F1 and the shutter speed is 1 second. The EV then increases by 1 each time the aperture increases by one F stop or the shutter speed increases by one increment. EV can also be used to indicate brightness and ISO settings.

**Exposure**

The amount of light used to capture an image. The exposure is determined by the length of time the shutter is open (shutter speed) and the amount of light that passes through the lens (aperture).

**Image pickup device**

This converts light passing through the lens into electrical signals. On this camera, light is picked up and converted into RGB signals to build a single image.

**ISO**

International abbreviation for International Organization for Standardization. The sensitivity setting used in digital cameras is based on the same ISO standard used for film sensitivity. The sensitivity is denoted as shown in "ISO 100". Higher ISO values indicate greater sensitivity to light, so images can be exposed even in low-light conditions.

**JPEG (Joint Photographic Experts Group)**

A compression format for color still images. Photographs (images) shot using this camera are recorded onto the card in JPEG format when the Record mode is set to a setting other than **[RAW]**. By downloading these images to a personal computer, users can edit them using graphics application software or view the images using an Internet web browser.

**M (Manual) Mode**

The user sets both the aperture and shutter speed.

**NTSC (National Television Systems Committee) / PAL (Phase Alternating Line)**

Television formats. NTSC is mainly used in Japan, North America and Korea. PAL is mainly used in Europe and China.

**Number of pixels (PIXEL COUNT)**

The number of dots (pixels) used to create an image denotes the image size. For instance, an image in 640 × 480 pixel count is the same size as the computer screen if the monitor setting is also 640 × 480. If the monitor setting is 1024 × 768, the image only takes up part of the screen.

**P (Program) Mode**

Also called Program AE mode. The camera automatically sets the best shutter speed and aperture for the shot.

**PictBridge**

A standard that enables digital cameras and printers made by different manufacturers to be connected, and also allows pictures to be printed directly from the camera.

**Pixels**

A pixel is the smallest unit (dot) used to make up an image. Clear large-sized printed images require millions of pixels.

**RAW**

Refers to raw data, data which has not been enhanced with a camera option like white balance, sharpness, contrast, etc. This file format is for viewing and processing with our own software. You may not be able to open or process these files with other graphics software applications, and these files cannot be selected for DPOF printing. RAW files are assigned an orf file extension (\*.orf).

**S (Shutter Priority) Mode**

Also called Shutter Priority AE mode. The user selects the shutter speed and the camera automatically varies the aperture so that the picture is taken with the best exposure.

**Single-lens reflex camera**

A camera that uses the reflective mirror to bend the light entering from the shooting lens and uses the viewfinder to check. There is no difference between the composition to be captured and the composition viewed on the viewfinder.

**Sleep Mode**

A mode designed to save battery life. The camera automatically enters the sleep mode if you do not operate it for a certain time. To get out of the sleep mode, use any button on the camera (shutter button, menu button, etc.).

**Spot metering**

The meter reading is taken from a very small area around the center of the subject, defined by the spot metering area mark in the viewfinder. Spot metering is ideal for use in difficult light conditions, or when the important element of the picture (subject's face) is small. Use spot metering for backlit subjects, or sports and stage performers. See also digital ESP metering and center weighted averaging metering.

**TFT (Thin-Film Transistor) Color Monitor**

A color monitor constructed using thin-film technology.

**TTL phase-contrast detection system**

This is used to measure the distance to the subject. The camera determines if the image is focused by the detected phase contrast.

**TTL (Through-The-Lens) System**

To help adjust exposure, a light receptor built into the camera directly measures the light passing through the lens.

# Specifications

## Camera specifications

### ■ Product type

Product type	: Single-lens reflex digital camera with interchangeable lens system
Lens	: Zuiko Digital, Four Thirds System Lens
Lens mount	: Four Thirds mount
Equivalent focal length on a 35 mm film camera	: Approx. twice the focal length of the lens

### ■ Image pickup device

Product type	: 4/3" Live MOS sensor
No. of total pixels	: Approx. 11,800,000 pixels
No. of effective pixels	: Approx. 10,100,000 pixels
Screen size	: 17.3 mm (H) × 13.0 mm (V) (0.7" × 0.5")
Aspect ratio	: 1.33 (4:3)

### ■ Viewfinder

Product type	: Eye-level single-lens reflex viewfinder
Field of view	: Approx. 100 % (for field of view on recorded images)
Viewfinder magnification	: Approx. 1.15× (-1 m <sup>-1</sup> , 50 mm lens, infinity)
Eye point	: Approx. 20 mm (0.8") from the cover glass (-1 m <sup>-1</sup> )
Diopter adjustment range	: -3.0 - +1.0 m <sup>-1</sup>
Optical path fraction	: Quick return half mirror
Depth of field	: Can be checked with the preview button (when PREVIEW registered with the <b>Fn</b> button)
Focusing screen	: Fixed
Eyecup	: Interchangeable

### ■ Live view

	: Uses Live MOS sensor for shooting
	: Field of view of 100%

### ■ LCD monitor

Product type	: 2.5" TFT color LCD (HyperCrystal LCD), adjustable
Total no. of pixels	: Approx. 230,000 pixels

### ■ Shutter

Product type	: Computerized focal-plane shutter
Shutter	: 1/8000 - 60 sec., Bulb shooting

### ■ Auto focus

Product type	: TTL phase-contrast detection system
Focusing points	: 11 points
AF luminance range	: EV -2 - EV 19
Selection of focusing point	: Auto, Optional
AF illuminator	: The built-in flash provides light.

### ■ Exposure control

Metering system	: TTL full-aperture metering system (1) Digital ESP metering (2) Center weighted averaging metering (3) Spot metering (approx. 2% for the viewfinder screen)
Metering range	: EV 1 - 20 (Digital ESP metering, Center weighted average metering, Spot metering) (At room temperature, 50 mm f2, ISO 100)
Shooting modes	: (1) <b>P</b> : Program AE (Program shift can be performed) (2) <b>A</b> : Aperture priority AE (3) <b>S</b> : Shutter priority AE (4) <b>M</b> : Manual (5) <b>B</b> : Bulb
ISO sensitivity	: 100 - 3200 (1/3, 1 EV step)
Exposure compensation	: ±5 EV (1/3, 1/2, 1 EV step)

## ■ White balance

- Product type : Image pickup device and white balance sensor  
 Mode setting : Auto, Preset WB (8 settings), Customized WB, One-touch WB (4 settings)

## ■ Recording

- Memory : CF card (Compatible with Type I and II)  
 Microdrive (Compatible with FAT 16/32)  
 xD-Picture Card  
 Recording system : Digital recording, JPEG (in accordance with Design rule for Camera File system (DCF)), RAW Data  
 Applicable standards : Exif 2.2, Digital Print Order Format (DPOF), PRINT Image Matching III, PictBridge

## ■ Playback

- Playback mode : Single-frame playback, Close-up playback, Index display, Image rotation, Slideshow, Light box display, Calendar display  
 Information display : Information display, Histogram display

## ■ Drive

- Drive mode : Single-frame shooting, Sequential shooting, Self-timer, Remote control  
 Sequential shooting : Approx. 5 frames/sec.  
 Self-timer : Operation time: 12 sec., 2 sec.  
 Optical remote control : Operation time: 2 sec., 0 sec. (instantaneous shooting)  
 (RM-1 Remote Control (optional))

## ■ Flash

- Synchronization : Synchronized with the camera at 1/250 sec. or less  
 Flash control mode : TTL-AUTO (TTL pre-flash mode), AUTO, MANUAL  
 External flash attachment : Hot shoe, external flash connector (x attachment)  
 Wireless flash function : Compatible with the Olympus wireless RC flash system

## ■ External connector

USB connector, DC-IN jack, VIDEO OUT jack, remote cable connector

## ■ Power supply

- Battery : Li-ion Battery (BLM-1) × 1  
 AC power : AC adapter (AC-1) (optional)

## ■ Dimensions/weight

- Dimensions : 142.5 mm (W) × 116.5 mm (H) × 74.5 mm (D) (5.6" × 4.6" × 2.9")  
 (excluding protrusions)  
 Weight : Approx. 810 g (1.8 lb.) (without battery)

## ■ Operating environment

- Temperature : 0°C - 40°C (32°F - 104°F) (operation)/  
 -20°C - 60°C (-4°F - 140°F) (storage)  
 Humidity : 30 - 90% (operation)/10 - 90% (storage)

## Battery/charger specifications

### BLM-1 Lithium ion battery

---

MODEL NO.	: PS-BLM1
Product type	: Rechargeable Lithium ion battery
Nominal voltage	: DC 7.2 V
Nominal capacity	: 1500 mAh
No. of charge and discharge times	: Approx. 500 times (varies with usage conditions)
Ambient temperature	: 0°C - 40°C (32°F - 104°F) (charging) -10°C - 60°C (14°F - 140°F) (operation) -20°C - 35°C (14°F - 95°F) (storage)
Dimensions	: Approx. 39 mm (W) × 55 mm (D) × 21.5 mm (H) (1.5" × 2.2" × 0.8")
Weight	: Approx. 75 g (0.2 lb.) (without protection cap)

### BCM-2 Lithium ion charger

---

MODEL NO.	: PS-BCM2
Rated input	: AC 100 V - 240 V (50/60 Hz)
Rated output	: DC 8.35 V, 400 mA
Charging time	: Approx. 5 hours (room temperature if using BLM-1)
Ambient temperature	: 0°C - 40°C (32°F - 104°F) (operation)/ -20°C - 60°C (-4°F - 140°F) (storage)
Dimensions	: Approx. 62 mm (W) × 83 mm (D) × 26 mm (H) (2.4" × 3.3" × 1.0")
Weight	: Approx. 72 g (0.2 lb.) (without AC cable)

**SPECIFICATIONS ARE SUBJECT TO CHANGE WITHOUT ANY NOTICE OR OBLIGATION ON THE PART OF THE MANUFACTURER.**



## SAFETY PRECAUTIONS



### CAUTION

RISK OF ELECTRIC SHOCK  
DO NOT OPEN



**CAUTION:** TO REDUCE THE RISK OF ELECTRICAL SHOCK, DO NOT REMOVE COVER (OR BACK). NO USER-SERVICEABLE PARTS INSIDE. REFER SERVICING TO QUALIFIED OLYMPUS SERVICE PERSONNEL.



An exclamation mark enclosed in a triangle alerts you to important operating and maintenance instructions in the documentation provided with the product.



#### DANGER

If the product is used without observing the information given under this symbol, serious injury or death may result.



#### WARNING

If the product is used without observing the information given under this symbol, injury or death may result.



#### CAUTION

If the product is used without observing the information given under this symbol, minor personal injury, damage to the equipment, or loss of valuable data may result.

### WARNING!

**TO AVOID THE RISK OF FIRE OR ELECTRICAL SHOCK, NEVER DISASSEMBLE, EXPOSE THIS PRODUCT TO WATER OR OPERATE IN A HIGH HUMIDITY ENVIRONMENT.**

## General Precautions

**Read All Instructions** — Before you use the product, read all operating instructions. Save all manuals and documentation for future reference.

**Cleaning** — Always unplug this product from the wall outlet before cleaning. Use only a damp cloth for cleaning. Never use any type of liquid or aerosol cleaner, or any type of organic solvent to clean this product.

**Attachments** — For your safety, and to avoid damaging the product, use only accessories recommended by Olympus.

**Water and Moisture** — For precautions on products with weatherproof designs, read the weatherproofing sections.

**Location** — To avoid damage to the product, mount the product securely on a stable tripod, stand, or bracket.

**Power Source** — Connect this product only to the power source described on the product label.

**Lightning** — If a lightning storm occurs while using an AC adapter, remove it from the wall outlet immediately.

**Foreign Objects** — To avoid personal injury, never insert a metal object into the product.

**Heat** — Never use or store this product near any heat source such as a radiator, heat register, stove, or any type of equipment or appliance that generates heat, including stereo amplifiers.

## Product Handling Precautions



### WARNING

- Do not use the camera near flammable or explosive gases.
- Do not use the flash and LED on people (infants, small children, etc.) at close range.
  - You must be at least 1 m (3 ft.) away from the faces of your subjects. Firing the flash too close to the subject's eyes could cause a momentary loss of vision.
- Keep young children and infants away from the camera.
  - Always use and store the camera out of the reach of young children and infants to prevent the following dangerous situations which could cause serious injury:
    - Becoming entangled in the camera strap, causing strangulation.
    - Accidentally swallowing the battery, cards or other small parts.
    - Accidentally firing the flash into their own eyes or those of another child.
    - Accidentally being injured by the moving parts of the camera.
- Do not look at the sun or strong lights with the camera.
- Do not use or store the camera in dusty or humid places.
- Do not cover the flash with a hand while firing.



### CAUTION

- Stop using the camera immediately if you notice any unusual odors, noise, or smoke around it.
  - Never remove the batteries with bare hands, which may cause a fire or burn your hands.
- Never hold or operate the camera with wet hands.
- Do not leave the camera in places where it may be subject to extremely high temperatures.
  - Doing so may cause parts to deteriorate and, in some circumstances, cause the camera to catch fire. Do not use the charger or AC adapter if it is covered (such as a blanket). This could cause overheating, resulting in fire.
- Handle the camera with care to avoid getting a low-temperature burn.
  - When the camera contains metal parts, overheating can result in a low-temperature burn. Pay attention to the following:
    - When used for a long period, the camera will get hot. If you hold on to the camera in this state, a low-temperature burn may be caused.
    - In places subject to extremely cold temperatures, the temperature of the camera's body may be lower than the environmental temperature. If possible, wear gloves when handling the camera in cold temperatures.
- Be careful with the strap.
  - Be careful with the strap when you carry the camera. It could easily catch on stray objects - and cause serious damage.

## Battery Handling Precautions

Follow these important guidelines to prevent batteries from leaking, overheating, burning, exploding, or causing electrical shocks or burns.



### DANGER

- The camera uses a lithium ion battery specified by Olympus. Charge the battery with the specified charger. Do not use any other chargers.
- Never heat or incinerate batteries.
- Take precautions when carrying or storing batteries to prevent them from coming into contact with any metal objects such as jewelry, pins, fasteners, etc.
- Never store batteries where they will be exposed to direct sunlight, or subjected to high temperatures in a hot vehicle, near a heat source, etc.
- To prevent causing battery leaks or damaging their terminals, carefully follow all instructions regarding the use of batteries. Never attempt to disassemble a battery or modify it in any way, by soldering, etc.
- If battery fluid gets into your eyes, flush your eyes immediately with clear, cold running water and seek medical attention immediately.
- Always store batteries out of the reach of small children. If a child accidentally swallows a battery, seek medical attention immediately.



### WARNING

- Keep batteries dry at all times.
- To prevent batteries from leaking, overheating, or causing a fire or explosion, use only batteries recommended for use with this product.
- Insert the battery carefully as described in the operating instructions.

- If rechargeable batteries have not been recharged within the specified time, stop charging them and do not use them.
- Do not use a battery if it is cracked or broken.
- If a battery leaks, becomes discolored or deformed, or becomes abnormal in any other way during operation, stop using the camera.
- If a battery leaks fluid onto your clothing or skin, remove the clothing and flush the affected area with clean, running cold water immediately. If the fluid burns your skin, seek medical attention immediately.
- Never subject batteries to strong shocks or continuous vibration.



## CAUTION

- Before loading, always inspect the battery carefully for leaks, discoloration, warping, or any other abnormality.
- The battery may become hot during prolonged use. To avoid minor burns, do not remove it immediately after using the camera.
- Always unload the battery from the camera before storing the camera for a long period.
- This camera uses a lithium ion battery specified by Olympus. Do not use any other type of battery. For safe and proper use, read the battery's instruction manual carefully before using it.
- If the battery's terminals get wet or greasy, camera contact failure may result. Wipe the battery well with a dry cloth before use.
- Always charge a battery when using it for the first time, or if it has not been used for a long period.
- When operating the camera with battery power at low temperatures, try to keep the camera and spare battery as warm as possible. A battery that has run down at low temperatures may be restored after it is warmed at room temperature.
- The number of pictures you can take may vary depending on the shooting conditions or battery.
- Before going on a long trip, and especially before traveling abroad, purchase extra batteries. A recommended battery may be difficult to obtain while traveling.
- Please recycle batteries to help save our planet's resources. When you throw away dead batteries, be sure to cover their terminals and always observe local laws and regulations.

## Caution for Usage Environment

- To protect the high-precision technology contained in this product, never leave the camera in the places listed below, no matter if in use or storage:
  - Places where temperatures and/or humidity are high or go through extreme changes. Direct sunlight, beaches, locked cars, or near other heat sources (stove, radiator, etc.) or humidifiers.
  - In sandy or dusty environments.
  - Near flammable items or explosives.
  - In wet places, such as bathrooms or in the rain. When using products with weatherproof designs, read their manuals as well.
  - In places prone to strong vibrations.
- Never drop the camera or subject it to severe shocks or vibrations.
- When mounted on a tripod, adjust the position of the camera with the tripod head. Do not twist the camera.
- Do not leave the camera pointed directly at the sun. This may cause lens or shutter curtain damage, color failure, ghosting on the image pickup device, or may possibly cause fires.
- Do not touch electric contacts on cameras and interchangeable lenses. Remember to attach the body cap when removing the lens.
- Before storing the camera for a long period, remove the battery. Select a cool, dry location for storage to prevent condensation or mold from forming inside the camera. After storage, test the camera by turning it on and pressing the shutter release button to make sure that it is operating normally.
- Always observe the operating environment restrictions described in the camera's manual.

## LCD Monitor

- Do not push the monitor forcibly; otherwise the image may become vague, resulting in a playback mode failure or damage to the monitor.
- A strip of light may appear on the top/bottom of the monitor, but this is not a malfunction.
- When a subject is viewed diagonally in the camera, the edges may appear zigzagged on the monitor. This is not a malfunction; it will be less noticeable in playback mode.
- In places subject to low temperatures, the LCD monitor may take a long time to turn on or its color may change temporarily. When using the camera in extremely cold places, it is a good idea to occasionally place it in a warm place. An LCD monitor exhibiting poor performance due to low temperatures will recover in normal temperatures.
- The LCD used for the monitor is made with high-precision technology. However, black spots or bright spots of light may appear constantly on the LCD Monitor. Due to its characteristics or the angle at which you are viewing the monitor, the spot may not be uniform in color and brightness. This is not a malfunction.

## Lens

- Do not immerse in water or splash with water.
- Do not drop or exert strong force on the lens.
- Do not hold at the moving part of the lens.
- Do not touch the lens surface directly.
- Do not touch the contact points directly.
- Do not subject to abrupt temperature changes.
- Do observe the operating temperature limit.

## Legal and Other Notices

- Olympus makes no representations or warranties regarding any damages, or benefit expected by using this unit lawfully, or any request from a third person, which are caused by the inappropriate use of this product.
- Olympus makes no representations or warranties regarding any damages or any benefit expected by using this unit lawfully which are caused by erasing picture data.

## Disclaimer of Warranty

- Olympus makes no representations or warranties, either expressed or implied, by or concerning any content of these written materials or software, and in no event shall be liable for any implied warranty of merchantability or fitness for any particular purpose or for any consequential, incidental or indirect damages (including but not limited to damages for loss of business profits, business interruption and loss of business information) arising from the use or inability to use these written materials or software or equipment. Some countries do not allow the exclusion or limitation of liability for consequential or incidental damages, so the above limitations may not apply to you.
- Olympus reserves all rights to this manual.

## Warning

Unauthorized photographing or use of copyrighted material may violate applicable copyright laws. Olympus assumes no responsibility for unauthorized photographing, use or other acts that infringe upon the rights of copyright owners.

## Copyright Notice

All rights reserved. No part of these written materials or this software may be reproduced or used in any form or by any means, electronic or mechanical, including photocopying and recording or the use of any type of information storage and retrieval system, without the prior written permission of Olympus. No liability is assumed with respect to the use of the information contained in these written materials or software, or for damages resulting from the use of the information contained therein. Olympus reserves the right to alter the features and contents of this publication or software without obligation or advance notice.

## FCC Notice

- Radio and Television Interference  
Changes or modifications not expressly approved by the manufacturer may void the user's authority to operate this equipment. This equipment has been tested and found to comply with the limits for a Class B digital device, pursuant to Part 15 of the FCC Rules. These limits are designed to provide reasonable protection against harmful interference in a residential installation.  
This equipment generates, uses, and can radiate radio frequency energy and, if not installed and used in accordance with the instructions, may cause harmful interference to radio communications. However, there is no guarantee that interference will not occur in a particular installation. If this equipment does cause harmful interference to radio or television reception, which can be determined by turning the equipment off and on, the user is encouraged to try to correct the interference by one or more of the following measures:
  - Adjust or relocate the receiving antenna.
  - Increase the distance between the camera and receiver.
  - Connect the equipment to an outlet on a circuit different from that to which the receiver is connected.
  - Consult your dealer or an experienced radio/TV technician for help. Only the OLYMPUS-supplied USB cable should be used to connect the camera to USB enabled personal computers (PC).

Any unauthorized changes or modifications to this equipment would void the user's authority to operate it.

## For customers in North and South America

### For customers in USA

Declaration of Conformity  
Model Number : E-3  
Trade Name : OLYMPUS  
Responsible Party : **OLYMPUS IMAGING AMERICA INC.**  
Address : 3500 Corporate Parkway, P.O. Box 610, Center Valley,  
PA 18034-0610, USA  
Telephone Number : 484-896-5000

Tested To Comply With FCC Standards  
FOR HOME OR OFFICE USE

This device complies with Part 15 of the FCC rules. Operation is subject to the following two conditions:

- (1) This device may not cause harmful interference.
- (2) This device must accept any interference received, including interference that may cause undesired operation.

### For customers in Canada

This Class B digital apparatus meets all requirements of the Canadian Interference-Causing Equipment Regulations.

## For customers in Europe



"CE" mark indicates that this product complies with the European requirements for safety, health, environment and customer protection. "CE" mark cameras are intended for sales in Europe.



This symbol [crossed-out wheeled bin WEEE Annex IV] indicates separate collection of waste electrical and electronic equipment in the EU countries. Please do not throw the equipment into the domestic refuse. Please use the return and collection systems available in your country for the disposal of this product.

### Use Only Dedicated Rechargeable Battery and Battery Charger

We strongly recommend that you use only the genuine Olympus dedicated rechargeable battery and battery charger with this camera.

Using a non-genuine rechargeable battery and/or battery charger may result in fire or personal injury due to leakage, heating, ignition or damage to the battery. Olympus does not assume any liability for accidents or damage that may result from the use of a battery and/or battery charger that are not genuine Olympus accessories.

### Provisions of warranty

1. If this product proves to be defective, although it has been used properly (in accordance with the written Handling Care and Operating instructions supplied with it), during a period of two years from the date of purchase from an authorized Olympus distributor within the business area of Olympus Imaging Europa GmbH as stipulated on the website: <http://www.olympus.com> this product will be repaired, or at Olympus's option replaced, free of charge. To claim under this warranty the customer must take the product and this Warranty Certificate before the end of the two year warranty period to the dealer where the product was purchased or any other Olympus service station within the business area of Olympus Imaging Europa GmbH as stipulated on the website: <http://www.olympus.com>. During the one year period of the World Wide Warranty the customer may turn the product in at any Olympus service station. Please notice that not in all countries such Olympus service station exists.
2. The customer shall transport the product to the dealer or Olympus authorized service station at his own risk and shall be responsible for any costs incurred in transporting the product.

3. This warranty does not cover the following and the customer will be required to pay repair charge, even for defects occurring within the warranty period referred to above.
  - (a) Any defect that occurs due to mishandling (such as an operation performed that is not mentioned in the Handling Care or other sections of the instructions, etc.)
  - (b) Any defect that occurs due to repair, modification, cleaning, etc. performed by anyone other than Olympus or an Olympus authorized service station.
  - (c) Any defect or damage that occurs due to transport, a fall, shock, etc. after purchase of the product.
  - (d) Any defect or damage that occurs due to fire, earthquake, flood damage, thunderbolt, other natural disasters, environmental pollution and irregular voltage sources.
  - (e) Any defect that occurs due to careless or improper storage (such as keeping the product under conditions of high temperature and humidity, near insect repellents such as naphthalene or harmful drugs, etc.), improper maintenance, etc.
  - (f) Any defect that occurs due to exhausted batteries, etc.
  - (g) Any defect that occurs due to sand, mud, etc. entering the inside of the product casing.
  - (h) When this Warranty Certificate is not returned with the product.
  - (i) When any alterations whatsoever are made to the Warranty Certificate regarding the year, month and date of purchase, the customer's name, the dealer's name, and the serial number.
  - (j) When proof of purchase is not presented with this Warranty Certificate.
4. This Warranty applies to the product only; the Warranty does not apply to any other accessory equipment, such as the case, strap, lens cap and batteries.
5. Olympus's sole liability under this warranty shall be limited to repairing or replacing the product. Any liability for indirect or consequential loss or damage of any kind incurred or suffered by the customer due to a defect of the product, and in particular any loss or damage caused to any lenses, films, other equipment or accessories used with the product or for any loss resulting from a delay in repair or loss of data, is excluded. Compelling regulations by law remain unaffected by this.

### Notes regarding warranty maintenance

1. This warranty will only be valid if the Warranty Certificate is duly completed by Olympus or an authorized dealer or other documents contain sufficient proof. Therefore, please make sure that your name, the name of the dealer, the serial number and the year, month and date of purchase are all completed or the original invoice or the sales receipt (indicating the dealer's name, the date of purchase and product type) is attached to this Warranty Certificate. Olympus reserves the right to refuse free-of-charge service if neither Warranty Certificate is completed nor the above document is attached or if the information contained in it is incomplete or illegible.
2. Since this Warranty Certificate will not be re-issued, keep it in a safe place.
- Please refer to the list on the web site: <http://www.olympus.com> for the authorized international Olympus service network.

## Trademarks

- IBM is a registered trademark of International Business Machines Corporation.
- Microsoft and Windows are registered trademarks of Microsoft Corporation.
- Macintosh is a trademark of Apple Inc.
- xD-Picture Card™ is a trademark.
- "Shadow Adjustment Technology" function contains patented technologies from Apical Limited.



- All other company and product names are registered trademarks and/or trademarks of their respective owners.
- The standards for camera file systems referred to in this manual are the "Design Rule for Camera File System/DCF" standards stipulated by the Japan Electronics and Information Technology Industries Association (JEITA).

# Index

## Symbols

	94
	96
IS (Image stabilizer)	60
(Language selection)	100
(Beep sound)	94
	95
↑ <sub>1</sub> Custom Menu 1	136
↑ <sub>2</sub> Custom Menu 2	138
	95
	92
	94
	136
	76
	97
	91
	135
	135
	96
	96
	90
	91
	94
	94
	96
	96
	97
	98
	99
	67
	67
	67
	67
4 h TIMER	95

## A

AC adapter	125
Accessories	123
Adobe RGB	97
AE BKT	48
AE bracketing	48
AE lock	47
AEL/AFL	92
AEL/AFL MEMO	92
AEL/Metering	96
AF AREA	54
AF AREA POINTER	90
AF ILLUMINAT.	90
AF MODE <b>AF</b>	51
AF SENSITIVITY	90
AF target mode	55
AF target	53
ALL	97
ALL ERASE	89

All target AF mode	53
ANTI-SHOCK	59
Aperture priority shooting <b>A</b>	41
Aperture value	40, 41
Auto flash AUTO	70
Auto focus	55, 114
Auto white balance AWB	62, 63

## B

B (Basic)	61, 117
B&W FILTER	67
BACKLIT LCD	95
Battery	11, 125
BULB FOCUSING	91
Bulb shooting <b>B</b>	44, 59
BULB TIMER	96
BUTTON TIMER	94

## C



















C-AF (continuous AF)	52
C-AF LOCK	90
C-AF+MF	53
Calendar display	81
CARD SETUP	89, 125
Cards	13, 124
Center weighted averaging metering	46
CF/xD	99
CLEANING MODE	122
Close-up playback <b>Q</b>	79
COLOR SPACE	97
Color temperature	132
CompactFlash	13, 124
Compression rate	61
Continuous AF (C-AF)	52
CONTRAST	67
Control panel	6
COPY ALL	86
CUSTOM	67
Custom printing	104
CUSTOM RESET	33
Custom white balance CWB	63

## D

Date/time setting	15
DIAL	91
Digital ESP metering	46
Diopter adjustment	14
Direct buttons	4, 27
Direct print	103
dpi SETTING	99
DPOF	101
Dust reduction	14, 121
Dynamic-single target AF mode	54











## E

Easy printing	104
---------------	-----

EDIT FILENAME .....	99	Menu .....	29
EV STEP .....	96	METERING  .....	45
Exposure compensation  .....	46	MF (manual focus) .....	52
EXT. WB DETECT .....	99	Microdrive .....	13, 124
Eyepiece shutter .....	58	Monitor adjustment  .....	99
<b>F</b> .....		MONOTONE .....	67
F (Fine) .....	61, 117	MTP .....	95, 112
FILE NAME .....	98	My mode   .....	44, 93
Fill-in flash  .....	71	MY MODE SETUP .....	93
FIRMWARE .....	100	<b>N</b> .....	
FL BKT .....	74	N (Normal) .....	61, 117
Flash bracketing .....	74	NOISE FILTER .....	69
Flash intensity control  .....	73	NOISE REDUCT. ....	69
Flash mode  .....	70	NTSC .....	100
Flash off  .....	71	Number of pixels .....	61
Focus lock .....	55	<b>O</b> .....	
FOCUS RING .....	90	OLYMPUS Master .....	107
FORMAT .....	125	Olympus wireless RC flash system .....	76
Four Thirds system lenses .....	126	One-touch white balance  .....	63, 65, 93
FRAME ASSIST .....	95	<b>P</b> .....	
<b>G</b> .....		PAL .....	100
GRADATION .....	68	PICT. TONE .....	67
<b>H</b> .....		PictBridge .....	103
HIGH KEY .....	68	PICTURE MODE .....	67
Histogram .....	32, 82, 117	PIXEL COUNT .....	98
Home position  .....	55	Pixel count .....	61
<b>I</b> .....		PIXEL MAPPING .....	122
IMAGE STABILIZER IS .....	60	Power battery holder .....	123
Index display  .....	81	Preset white balance .....	62, 63
Information display .....	32, 82	PREVIEW .....	92
ISO BKT .....	50	Preview .....	45
ISO bracketing .....	50	Print mode  .....	105
ISO ISO .....	49	Print reservation .....	101
ISO STEP .....	96	PRIORITY SET .....	99
ISO-AUTO .....	96	Program shift <b>Ps</b> .....	40
ISO-AUTO SET .....	96	Program shooting <b>P</b> .....	40
<b>J</b> .....		Protecting <b>O-m</b> .....	86
JPEG EDIT .....	84	<b>Q</b> .....	
<b>L</b> .....		QUICK ERASE .....	98
<b>L</b> (Large) .....	61, 117	<b>R</b> .....	
Lens .....	12, 126	RAW .....	61
Light box display .....	80	RAW DATA EDIT .....	84
Lithium ion battery .....	11, 125	RAW+JPEG ERASE .....	98
Lithium ion charger .....	11, 123, 125	REC VIEW .....	100
LIVE PREVIEW .....	45, 92	Record mode  .....	61, 62, 133
Live view .....	31	Red-eye reduction flash  .....	70
LIVE VIEW BOOST .....	95	Remote control  .....	58
LOW KEY .....	68	RESET LENS .....	91
<b>M</b> .....		RESET PROTECT .....	87
<b>M</b> (Middle) .....	61, 117	Resizing  .....	84
Manual flash .....	72	RLS PRIORITY C .....	94
Manual focus (MF) .....	52	RLS PRIORITY S .....	94
Manual shooting <b>M</b> .....	43	Rotating images  .....	83





**S**

<b>S</b> (Small) .....	61, 117
S-AF (single AF) .....	51
S-AF+MF .....	53
SATURATION .....	67
Self-timer  .....	57
Sequential shooting H  .....	56
Sequential shooting L  .....	56
SF (Super Fine) .....	61, 117
SHADING COMP. ....	97
SHADOW ADJ .....	84
SHARPNESS .....	67
Shutter priority shooting <b>S</b> .....	42
Shutter speed .....	40, 42
Single AF (S-AF) .....	51
Single target AF mode [ <b>•</b> ] .....	53
Single-frame copy .....	85
Single-frame erase  .....	88
Single-frame playback .....	79
Single-frame protect .....	86
Single-frame shooting  .....	56
SLEEP .....	94
Slideshow  .....	83
Slow synchronization  SLOW .....	70
Slow synchronization  SLOW2/2nd CURTAIN .....	71
Small-single target AF mode [ <b>•</b> ]s .....	53, 90
Spot metering - highlight control  <b>H</b> / .....	46
Spot metering - shadow control  <b>S</b> <b>H</b> .....	46
Spot metering  .....	46
sRGB .....	97
STORAGE .....	95, 108
Strap .....	10
Super control panel .....	7, 28
Super FP flash .....	76

**T**

TEST PICTURE .....	93
--------------------	----

**U**

Under water macro  .....	44, 93
Under water wide  .....	44, 93
USB MODE .....	95

**V**

VIDEO OUT .....	100
Viewfinder .....	5, 14, 16

**W**

WB .....	63
WB BKT .....	66
WB compensation .....	64
White balance bracketing .....	66
White balance sensor .....	64
White balance <b>WB</b> .....	62

**X**

xD-Picture Card .....	13, 124
-----------------------	---------

**Z**

ZUIKO DIGITAL interchangeable lens .....	126
--	-----





# OLYMPUS®

<http://www.olympus.com/>

## OLYMPUS IMAGING CORP.

Shinjuku Monolith, 3-1 Nishi-Shinjuku 2-chome, Shinjuku-ku, Tokyo, Japan

## OLYMPUS IMAGING AMERICA INC.

3500 Corporate Parkway, P.O. Box 610, Center Valley, PA 18034-0610, USA Tel. 484-896-5000

### Technical Support (USA)

24/7 online automated help: <http://www.olympusamerica.com/DSLRL>

Phone customer support: Tel. 1-800-260-1625 (Toll-free)

Our phone customer support is available from 8 am to 10 pm (Monday to Friday) ET

E-Mail: [e-slrpro@olympus.com](mailto:e-slrpro@olympus.com)

Olympus software updates can be obtained at: <http://www.olympusamerica.com/digital>

To find the nearest Service Centers, please visit: <http://www.olympusamerica.com/digital>, and click on the Worldwide Warranty icon at the bottom of the page.

### Service Centers

#### USA:

##### California

**Olympus Imaging America Inc.**  
10805 Holder Street Suite 170  
Cypress, CA 90630-5145  
Tel: (800) 260-1625  
FAX: (714) 229-1652

##### New York

**Olympus Imaging America Inc.**  
400 Rabro Drive  
Hauppauge, NY 11788-4258  
Tel: (800) 260-1625  
FAX: (631) 881-6510

#### Canada:

##### Olympus Canada Inc.

Consumer Products Group  
151 Telson Road  
Markham, Ontario Canada L3R 1E7  
Tel: (800) 260-1625  
Fax: (905) 969-3291

## OLYMPUS IMAGING EUROPA GMBH

Premises: Wendenstrasse 14-18, 20097 Hamburg, Germany

Tel: +49 40-23 77 3-0 / Fax: +49 40-23 07 61

Goods delivery: Bredowstrasse 20, 22113 Hamburg, Germany

Letters: Postfach 10 49 08, 20034 Hamburg, Germany

### European Technical Customer Support:

Please visit our homepage <http://www.olympus-europa.com>

or call our TOLL FREE NUMBER\* : **00800 - 67 10 83 00**

for Austria, Belgium, Denmark, Finland, France, Germany, Italy, Luxembourg, Netherlands, Norway, Portugal, Spain, Sweden, Switzerland, United Kingdom

\* Please note some (mobile) phone services providers do not permit access or request an additional prefix to +800 numbers.

For all European Countries not listed and in case that you can't get connected to the above mentioned number, please make use of the following

CHARGED NUMBERS: **+49 180 5 - 67 10 83** or **+49 40 - 237 73 4899**

Our Technical Customer Support is available from 9 am to 6 pm MET (Monday to Friday)